

AC SERVO DRIVES

M, F, S SERIES FOR POSITIONING CONTROL

SERVOMOTOR TYPES : USAMED, USAFED, USASEM
(With Incremental Encoder)

SERVOPACK TYPE : CACR-PR□BC (Rack-mounted Type)

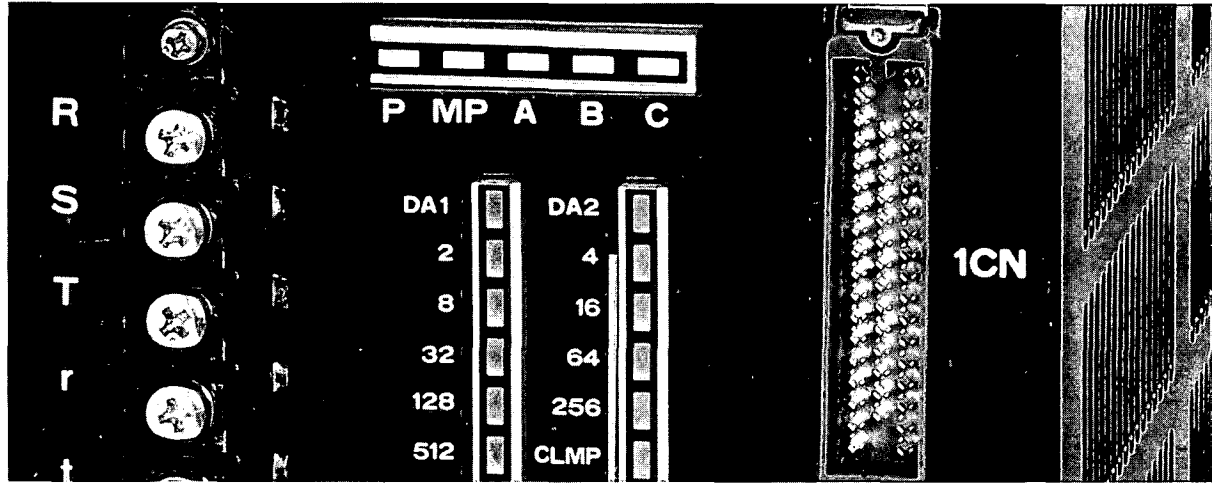

YASKAWA

大阪支店移転のお知らせ

◆平成8年7月1日から下記の住所に変わります。ご注意ください。

新住所 〒530 大阪市北区堂島2丁目4番27号
新藤田ビル4階

電話番号 (06)346-4500 (代表)

FAX番号 (06)346-4555 (06)346-4556 (新設)

業務開始日 平成8年7月1日(月)

Change of address

We are pleased to announce the relocation of YASKAWA ELECTRIC CORPORATION Osaka Office with effect from July 1 1996, to the following address;

Address : Shin-Fujita Building, 2-4-27, Doujima,
Kita-ku, Osaka 530, Japan

Phone : (06)346-4500 Fax : (06)346-4555, (06)346-4556

◆技術的問い合わせ相談窓口は次のとおりです。

- ・インバータ応用技術課 電話番号 (06)346-4512
FAX番号 (06)346-4555
- ・メカトロ技術課 電話番号 (06)346-4513
(サーボ, マシンコントロール) FAX番号 (06)346-4555

東京支社移転のお知らせ

◆平成8年5月7日から下記の住所に変わりました。ご注意ください。

新住所 〒105 東京都港区海岸1丁目16番1号
ニューピア竹芝サウスタワービル8階

電話番号 (03)5402-4511 (代表)

FAX番号 (03)5402-4580

業務開始日 平成8年5月7日(火)

Change of address

We are pleased to announce the relocation of YASKAWA ELECTRIC CORPORATION Tokyo Branch, with effect from May 7 1996, to the following address;

Address : New Pier Takeshiba South Tower, 1-16-1, Kaigan,
Minatoku, Tokyo 105, Japan

Phone : (03)5402-4511 Fax : (03)5402-4580

◆技術的問い合わせ相談窓口は次のとおりです。

- ・インバータ応用技術課 電話番号 (03)5402-4546
- ・サーボ応用技術課 FAX番号 (03)5402-4588
- ・マシンコントロール応用技術課

Yaskawa AC Servo Series has been developed as basic mechatronics drive for the most advanced FA and FMS. The extensive DC servo manufacturing technology accumulated through a half century of servo drive applications created and nurtured a new phase of AC servo drives.

The AC servo drives consist of a flexible combination of our AC SERVOMOTOR and its controller, SERVOPACK. The AC SERVOMOTOR features a high-power rate for achieving quick response. The AC SERVOPACK type CACR-PR□BC is designed for integrated construction of Positionpack for digital positioning control (type CPCC-PP100) and AC SERVOPACK for speed control (type CACR-SR□BB).

For your mechatronics systems, our AC servo drives achieves stable control operation with high accuracy, quick response control even under adverse environmental conditions. Furthermore, these have succeeded in providing reliable, durable and easy maintenance by various display and protective functions. Some outstanding features are as follows :

- High accuracy and quick response for speed control
- Rack-mounted type to conserve mounting space
- Easy maintenance by a wide range of display functions
- Highly reliable protective functions
- Selectable drive to suit the requirement
- Applicable to multiaxis applications

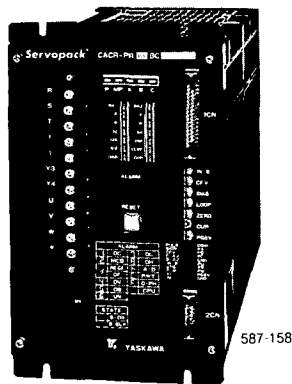

Type CACR-PR10BC

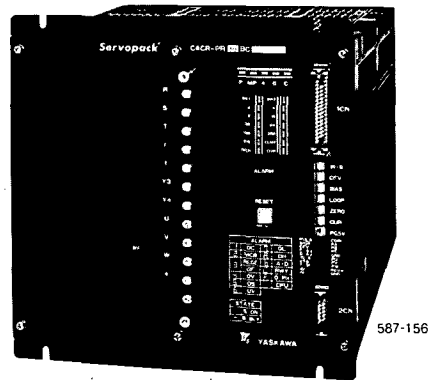

Type CACR-PR30BC

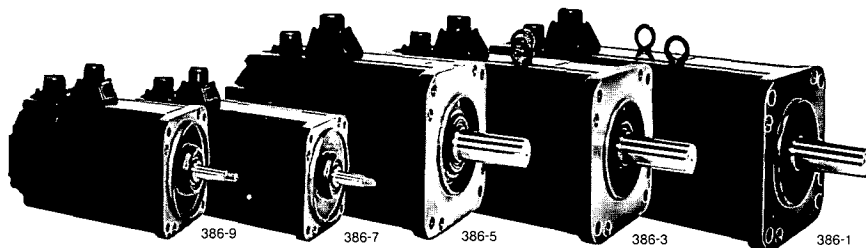

Type USAMED-03MA1

Type USAMED-09MA2

Type USAMED-44MA2

Type USAMED-06MA1

Type USAMED-20MA2

M Series AC Servo Drives for Speed Control
 — AC SERVOMOTORS and Their Controllers SERVOPACKS —

CONTENTS

1. RATINGS AND SPECIFICATIONS	1	6.7 SETTING OF INTERNAL SWITCHES	36
1.1 M SERIES AC SERVOMOTORS	1	6.8 ADJUSTMENT	39
1.2 F SERIES AC SERVOMOTORS	3	6.9 CHECK TERMINAL	41
1.3 S SERIES AC SERVOMOTORS	5	6.10 PRECAUTIONS FOR APPLICATION	42
1.4 RATINGS AND SPECIFICATIONS OF SERVOPACK	7	6.11 PRECAUTIONS FOR OPERATION	42
		6.12 APPLICATION	44
2. TYPE DESIGNATION	8	7. INSTALLATION AND WIRING	45
3. LIST OF STANDARD COMBINATION	9	7.1 RECEIVING	45
4. CHARACTERISTICS	12	7.2 INSTALLATION	45
4.1 OVERLOAD CHARACTERISTICS	12	7.3 WIRING	46
4.2 STARTING AND STOPPING TIME	12	8. DIMENSIONS in mm (inches)	48
4.3 ALLOWABLE FREQUENCY OF OPERATION	12	8.1 SERVOMOTOR: M SERIES	48
4.4 MOTOR MECHANICAL CHARACTERISTICS	14	8.2 SERVOMOTOR: F SERIES	50
		8.3 SERVOMOTOR: S SERIES	53
5. CONFIGURATION	16	8.4 SERVOPACK	57
5.1 CONNECTION DIAGRAM	16	8.5 PERIPHERAL EQUIPMENT	58
5.2 INTERNAL BLOCK DIAGRAM	17	9. TEST SUN	59
5.3 EXTERNAL TERMINALS	18	9.1 CHECK ITEMS BEFORE TEST RUN	59
5.4 CONNECTOR TERMINAL(1CN) FOR I/O SIGNAL	18	9.2 TEST RUN PROCEDURES	59
5.5 CONNECTOR TERMINAL(2CN)FOR OPTICAL ENCODER(PG)CONNECTION	21	10. ADJUSTMENT	60
6. OPERATION	23	10.1 SETTING AT THE TIME OF DELIVERY	60
6.1 POWER ON AND OFF	23	10.2 LIST OF CHECK TERMINALS AND POTENTIOMETER	65
6.2 CONFIGURATION OF I/O CIRCUIT	23	10.3 ADJUSTMENT PROCEDURES	66
6.3 PROTECTIVE CIRCUIT	31	11. INSPECTION AND MAINTENANCE	67
6.4 CONFIGURATION OF POSITIONING CONTROL LOOP	33	11.1 AC SERVOMOTOR	67
6.5 RESOLUTION OF POSITIONING FEEDBACK PULSE	35	11.2 SERVOPACK	67
6.6 DISPLAY	35	12. TROUBLESHOOTING GUIDE	68
		12.1 AC SERVOMOTOR	68
		12.2 SERVOPACK	69

INDEX

Subject	Chapter	Section No.	Page
A AC SERVOMOTOR (INSPECTION AND MAINTENANCE)	11	11.1	67
AC SERVOMOTOR (TROUBLESHOOTING GUIDE)	12	12.1	68
ADJUSTMENT	10		60
ADJUSTMENT (POTENTIOMETER)	6	6.8	39
ADJUSTMENT PROCEDURES	10	10.3	66
ALLOWABLE FREQUENCY OF OPERATION	4	4.3	12
Allowable Radial Load and Thrust Load	4	4.4.2	14
APPLICATION	6	6.12	44
C CHARACTERISTICS	4		12
CHECK ITEMS BEFORE TEST RUN	9	9.1	59
CHECK TERMINAL	6	6.9	41
CONFIGURATION	5		16
CONFIGURATION OF I/O CIRCUIT	6	6.2	23
CONFIGURATION OF POSITIONING CONTROL LOOP	6	6.4	33
CONNECTION DIAGRAM	5	5.1	16
Connection for Reverse Motor Running	6	6.12.1	44
Connector 1CN Layout and Connection of SERVOPACK	5	5.4.2	18
CONNECTOR TERMINAL (1CN) FOR I/O SIGNAL	5	5.4	18
CONNECTOR TERMINAL (2CN) FOR OPTICAL ENCODER (PG) CONNECTION	5	5.5	21
D DIMENSIONS in mm (inches)	8		48
Direction of Rotation	4	4.4.4	14
DISPLAY	6	6.6	35
E Examples of Troubleshooting for Defective Wiring or Parts	12	12.2.2	70
Examples of Troubleshooting for Incomplete Adjustment	12	12.2.3	70
EXTERNAL TERMINALS	5	5.3	18
F Frequency Dividing (1) Setting (I/D ₁)	6	6.4.1	33
Frequency Dividing (2) Setting (I/D ₂)	6	6.4.3	33
H High Voltage Line	6	6.10.3	42
Holding Brake	4	4.4.8	15
I Impact Resistance	4	4.4.5	15
Input Circuit	6	6.2.1	23
I/O Signal of Connector 1CN	5	5.4.3	20
INSPECTION AND MAINTENANCE	11		67
Inspection during Test Run	9	9.2.3	59
INSTALLATION	7	7.2	45
INSTALLATION AND WIRING	7		45
INTERNAL BLOCK DIAGRAM	5	5.2	17
Internal Switch Arrangements	6	6.7.2	38
L LED Indicator (7-segment) for Troubleshooting	12	12.2.1	69
LIST OF CHECK TERMINALS AND POTENTIOMETER	10	10.2	65
List of Switch Setting	10	10.1.1	61
LIST OF STANDARD COMBINATION	3		9
Load Inertia (GD ²)	6	6.10.2	42
M MOTOR MECHANICAL CHARACTERISTICS	4	4.4	14
Mechanical Specifications (M, F and S series)	4	4.4.3	14
Mechanical Strength	4	4.4.1	14
Minus Load	6	6.10.1	42
Multiplier Setting (M)	6	6.4.2	33
N Noise Control	6	6.11.1	42
O OPERATION	6		23
Operation	9	9.2.2	59
Optical Encoder (PG) Output Circuit	6	6.2.3	29
Output Circuit	6	6.2.2	28

INDEX (Cont'd)

Subject	Chapter	Section No.	Page
OVERLOAD CHARACTERISTICS	4	4.1	12
P PERIPHERAL EQUIPMENT	8	8.5	58
Potentiometer Setting	10	10.1.2	64
Power Line Protection	6	6.11.2	43
Power Loss	7	7.3.3	47
POWER ON AND OFF	6	6.1	23
PRECAUTIONS FOR APPLICATION	6	6.10	42
PRECAUTIONS OF OPERATION	6	6.11	42
Preparation for Operation	9	9.2.1	59
PROTECTIVE CIRCUIT	6	6.3	31
R Rated Current and Cable Size	7	7.3.1	46
RATINGS AND SPECIFICATIONS	1		1
RATING SPECIFICATIONS (F SERIES AC SERVOMOTORS)	1	1.2	3
RATING SPECIFICATIONS (M SERIES AC SERVOMOTORS)	1	1.1	1
RATING SPECIFICATIONS (S SERIES AC SERVOMOTORS)	1	1.3	5
RATINGS AND SPECIFICATIONS OF SERVOPACK	1	1.4	7
Ratings (F Series AC SERVOMOTORS)	1	1.2.1	3
Ratings (M Series AC SERVOMOTORS)	1	1.1.1	1
Ratings (S Series AC SERVOMOTORS)	1	1.3.1	5
RECEIVING	7	7.1	45
RESOLUTION OF POSITIONING FEEDBACK PULSE	6	6.5	35
S Servomotor (Check Items before Test Run)	9	9.1.1	59
SERVOMOTOR: F SERIES (DIMENSIONS)	8	8.2	50
SERVOMOTOR: M SERIES (DIMENSIONS)	8	8.1	48
SERVOMOTOR: S SERIES (DIMENSIONS)	8	8.3	53
SERVOMOTOR (Installation)	7	7.2.1	45
SERVOPACK (Check Items before Test Run)	9	9.1.2	59
SERVOPACK Connector (2CN) Terminal Layout and Connection	5	5.5.2	21
SERVOPACK (DIMENSIONS)	8	8.4	57
SERVOPACK (INSPECTION AND MAINTENANCE)	11	11.2	67
SERVOPACK (Installation)	7	7.2.2	46
SERVOPACK (TROUBLESHOOTING GUIDE)	12	12.2	69
SETTINGS AT THE TIME OF DELIVERY	10	10.1	60
SETTING OF INTERNAL SWITCHES	6	6.7	36
Specifications of Applicable Receptacles	5	5.4.1	18
Specifications of Applicable Receptacles and Cables	5	5.5.1	21
STARTING AND STOPPING TIME	4	4.2	12
Switch Functions	6	6.7.1	36
Switch Setting Procedure	6	6.7.3	39
T TEST RUN	9		59
TEST RUN PROCEDURES	9	9.2	59
Torque Reference Monitor and Speed Monitor (TRO-M, VTG-M)	6	6.2.4	31
Torque-Speed Characteristics (F Series AC Servomotors)	1	1.2.2	4
Torque-Speed Characteristics (M Series AC Servomotors)	1	1.1.2	2
Torque-Speed Characteristics (S Series AC Servomotors)	1	1.3.2	6
TROUBLESHOOTING GUIDE	12		68
TYPE DESIGNATION	2		8
U Use of SERVOMOTOR with Holding Magnetic Brake	6	6.12.2	44
V Vibration Class	4	4.4.7	15
Vibration Resistance	4	4.4.6	15
W WIRING	7	7.3	46
Wiring Precautions	7	7.3.2	47

1. RATINGS AND SPECIFICATIONS

1.1 M SERIES AC SERVOMOTORS

1.1.1 Ratings

Time Rating: Continuous

Insulation: Class F

Isolation Voltage: 1500 VAC, one minute

Insulation Resistance: 500 VDC, 10MΩ or more

Enclosure: Totally-enclosed, self-cooled
(Equivalent to IP-55 exclusive shaft opening)

Ambient Temperature: 0 to +40°C

Ambient Humidity: 20% to 80% (non-condensing)

Vibration: 15 μm or below

Finish in Munsell Notation: N1.5

Excitation: Permanent magnet

Mounting: Flange mounted

Drive Method: Direct drive

Table 1.1 Ratings and Specifications of M Series AC SERVOMOTORS

Item	Motor Type USAMED-	Motor Type USAMED-						
		03M□1	06M□1	09M□2	12M□2	20M□2	30M□2	44M□2
Rated Output*	kW (HP)	0.3 (0.4)	0.6 (0.8)	0.9 (1.2)	1.2 (1.6)	2.0 (2.7)	3.0 (4.1)	4.4 (6.0)
Rated Torque*	N·m (lb·in)	2.8 (25)	5.7 (50)	8.6 (76)	11.5 (102)	19.1 (169)	28.4 (252)	41.9 (372)
Continuous Max Torque*	N·m (lb·in)	2.9 (26)	5.9 (52)	8.8 (78)	11.8 (104)	21.6 (191)	32.3 (286)	46.1 (408)
Instantaneous Max Torque*	N·m (lb·in)	7.2 (63)	14.1 (125)	19.3 (171)	28.0 (248)	44.0 (390)	63.7 (564)	91.1 (807)
Rated Current*	A	3.0	5.8	7.6	11.7	18.8	26	33
Rated Speed*	r/min	1000						
Instantaneous Max Speed*	r/min	2000						1500
Torque Constant	N·m/A (lb·in/A)	1.01 (8.9)	1.04 (9.2)	1.21 (10.7)	1.02 (9.0)	1.07 (9.5)	1.15 (10.2)	13.6 (11.8)
Moment of Inertia $J_M (=GD^2/4)$	$kg \cdot m^2 \times 10^{-4}$ ($lb \cdot in \cdot s^2 \times 10^{-3}$)	13.5 (12.0)	24.3 (21.5)	36.7 (32.5)	66.8 (59.2)	110 (97.2)	143 (126.7)	240 (212.6)
Power Rate*	kW/s	6.1	13.3	20.3	19.7	33.2	57.0	74.0
Inertia Time Constant	ms	8.3	5.9	4.6	6.9	5.2	4.1	4.0
Inductive Time Constant	ms	4.2	5.4	6.5	10.4	12.9	15.3	16.2

*Values when SERVOMOTOR is combined with SERVOPACK and the armature winding temperature is 20°C. Shown are normal (TYP) values above.

Notes:

- in type designation is determined by output pulses (pulses/rev) of optical encoder as follows:
Standard: A (6000 pulses/rev)
Optional: B (5000 pulses/rev), D (4000 pulses/rev)
- There are two types of power supply units for brakes.
• Input 100 VAC, output 90 VDC (OPR 109 F)
• Input 200 VAC, output 90 VDC (OPR 109 A)
For details, refer to Par. 8.5, "PERIPHERAL EQUIPMENT."

1. 1. 2 Torque-Speed Characteristics

• TYPE USAMED-03M

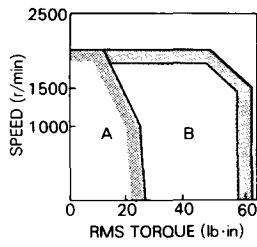
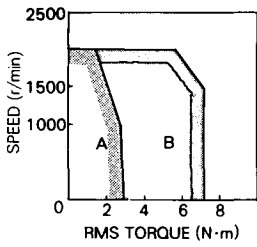

• TYPE USAMED-20M

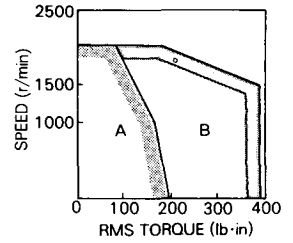
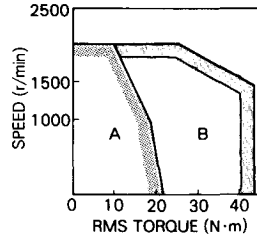

• TYPE USAMED-06M

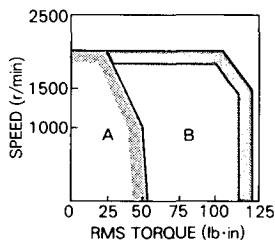
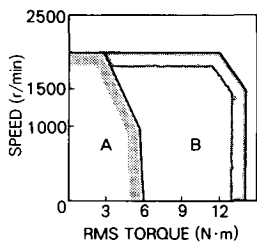

• TYPE USAMED-30M

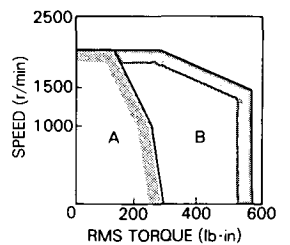
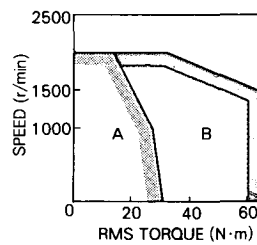

• TYPE USAMED-09M

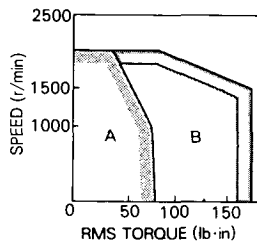
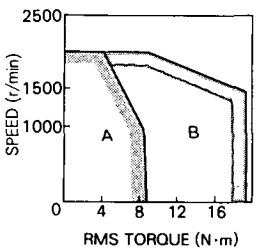

• TYPE USAMED-44M

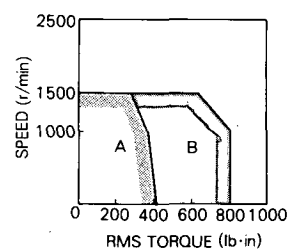
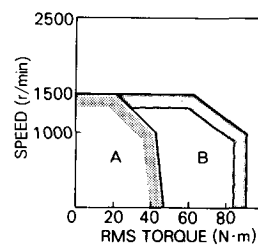

• TYPE USAMED-12M

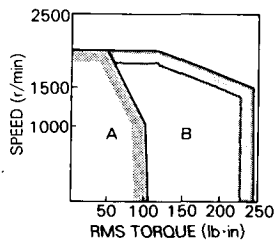
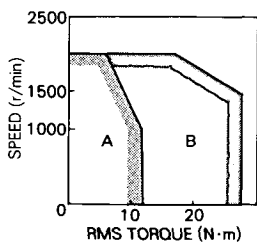

• TYPE USAMKD-60M

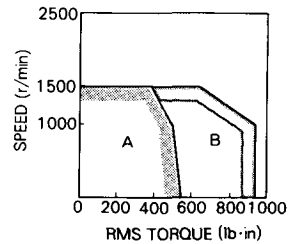
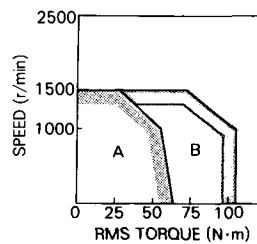

A: CONTINUOUS DUTY ZONE
 B: INTERMITTENT DUTY ZONE
 POWER SUPPLY: 200V

1.2 F SERIES AC SERVOMOTORS

1.2.1 Ratings

Time Rating: Continuous

Insulation: Class F

Isolation Voltage: 1500 VAC, one minute

Insulation Resistance: 500 VDC, 10M Ω or more

Enclosure: Totally-enclosed, self-cooled

(Equivalent to IP-55 exclusive shaft opening)

Ambient Temperature: 0 to +40°C

Ambient Humidity: 20% to 80% (non-condensing)

Vibration: 15 μ m or below

Finish in Munsell Notation: N1.5

Excitation: Permanent magnet

Mounting: Flange mounted

Drive Method: Direct drive

Table 1.2 Ratings and Specifications of F Series AC SERVOMOTORS

Item	Motor Type USAFED-	02F□□1	03F□□1	05F□□1	09F□□1	13F□□2	20F□□2	30F□□2	44F□□2
Rated Output*	kW (HP)	0.15 (0.2)	0.3 (0.4)	0.45 (0.6)	0.85 (1.2)	1.3 (1.8)	1.8 (2.4)	2.9 (3.9)	4.4 (6.0)
Rated Torque*	N·m (lb·in)	1.0 (8.7)	2.0 (17)	2.8 (25)	5.4 (48)	8.3 (74)	11.5 (102)	18.6 (165)	28.4 (252)
Continuous Max Torque*	N·m (lb·in)	1.1 (10)	2.2 (19)	2.9 (26)	5.9 (52)	8.8 (78)	11.8 (104)	22.5 (200)	37.2 (330)
Instantaneous Max Torque*	N·m (lb·in)	2.9 (26)	5.7 (51)	8.9 (79)	15.2 (135)	24.7 (219)	34.0 (301)	54.1 (479)	76.2 (675)
Rated Current*	A	3.0	3.0	3.8	6.2	9.7	15	20	30
Rated Speed*	r/min	1500							
Instantaneous Max Speed*	r/min	2500							
Torque Constant	N·m/A (lb·in/A)	0.36 (3.2)	0.71 (6.3)	0.81 (7.1)	0.92 (8.2)	0.92 (8.2)	0.82 (7.3)	0.98 (8.7)	1.01 (9.0)
Moment of Inertia $J_M (=GD^2/4)$	kg·m ² ×10 ⁻⁴ (lb·in·s ² ×10 ⁻³)	1.3 (1.1)	2.0 (1.8)	13.5 (12.0)	24.3 (21.5)	36.7 (32.5)	66.8 (59.2)	110 (97.2)	143 (126.7)
Power Rate*	kW/s	7.4	18.3	6.0	12	18.9	19.7	31.5	57.0
Inertia Time Constant	ms	4.5	2.5	8.3	5.7	4.7	6.8	5.1	4.1
Inductive Time Constant	ms	3.4	4.3	4.2	5.5	6.4	10.4	13.0	15.2

*Values when SERVOMOTOR is combined with SERVOPACK and the armature winding temperature is 20°C. Shown are normal (TYP) values above.

Notes:

- in type designation is determined by output pulses (pulses/rev) of optical encoder as follows:
Standard: A (6000 pulses/rev)
Optional: B (5000 pulses/rev), D (4000 pulses/rev)
- There are two types of power supply units for brake.
• Input 100 VAC, output 90 VDC (OPR 109 F)
• Input 200 VAC, output 90 VDC (OPR 109 A)
For details, refer to Par. 8.5, "PERIPHERAL EQUIPMENT."

1. 2. 2 Torque-Speed Characteristics

• TYPE USAFED-02F

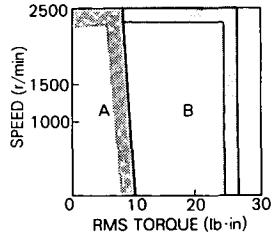
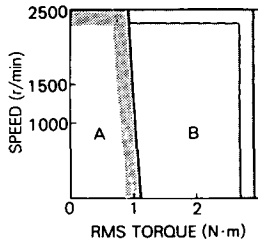

• TYPE USAFED-13F

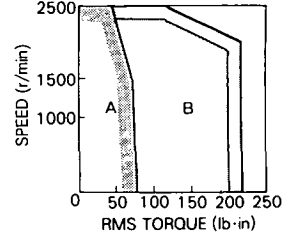
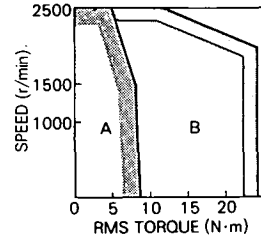

• TYPE USAFED-03F

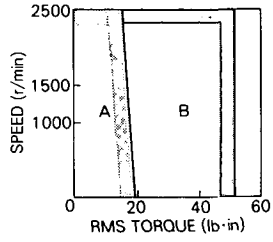
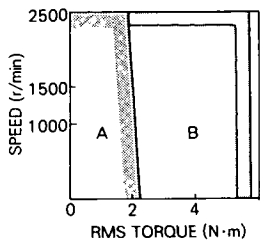

• TYPE USAFED-20F

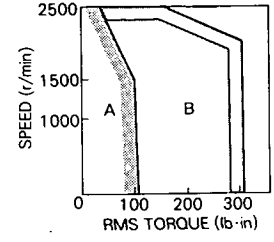
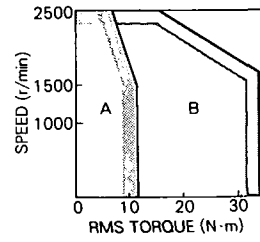

• TYPE USAFED-05F

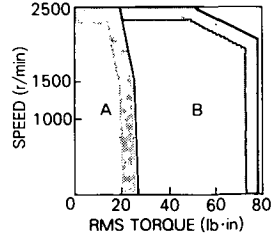
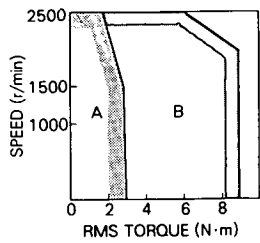

• TYPE USAFED-30F

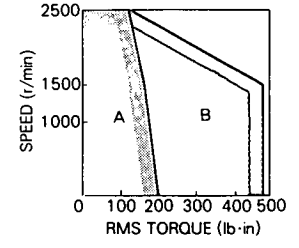
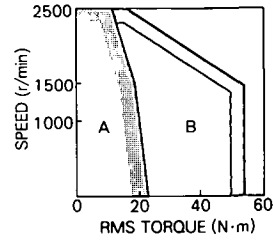

• TYPE USAFED-09F

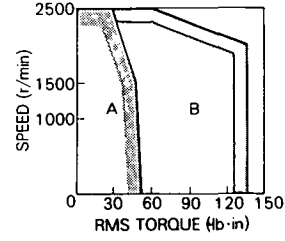
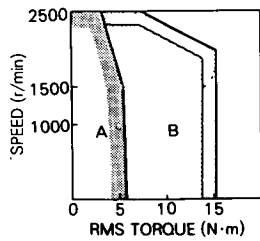

• TYPE USAFED-44F

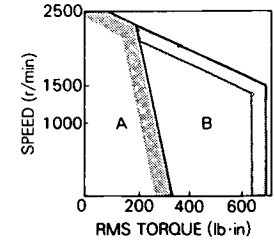
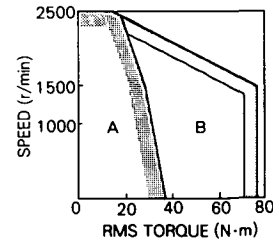

A: CONTINUOUS DUTY ZONE
 B: INTERMITTENT DUTY ZONE
 POWER SUPPLY: 200V

1.3 S SERIES AC SERVOMOTORS

1.3.1 Ratings

Time Rating: Continuous

Insulation: Class B (Types USASEM-03A□2,
-05A□2)
Coass F (Types USASEM-08A□1,
-15A□1, -30A□1)

Isolation Voltage: 1500 VAC, one minute

Insulation Resistance: 500 VDC, 10MΩ or more

Enclosure: Totally-enclosed, self-cooled

Ambient Temperature: 0 to +40°C

Ambient Humidity: 20% to 80% (non-condensing)

Vibration: 15 μm or below

Finish in Munsell Notation: N1.5

Excitation: Permanent magnet

Mounting: Flange mounted

Drive Method: Direct drive

Table 1.3 Ratings and Specifications of S Series AC SERVOMOTORS

Item	Motor Type USASEM-	Motor Type USASEM-					
		02A□2	03A□2	05A□2	08A□1	15A□1	30A□1
Rated Output*	W (HP)	154 (0.2)	308 (0.4)	462 (0.6)	771 (1.1)	1540 (2.1)	3080 (4.2)
Rated Torque*	N·m (lb·in)	0.49 (4.3)	0.98 (8.7)	1.47 (13)	2.45 (22)	4.90 (43)	9.80 (87)
Continuous Max Torque*	N·m (lb·in)	0.57 (5.0)	1.18 (10)	1.67 (15)	3.33 (30)	6.17 (55)	12.2 (108)
Instantaneous Max Torque*	N·m (lb·in)	1.47 (13)	2.94 (26)	4.02 (36)	7.35 (65)	13.7 (122)	29.0 (257)
Rated Current*	A	2.1	3.0	4.2	5.3	10.4	19.9
Rated Speed*	r/min	3000					
Instantaneous Max Speed*	r/min	4000					
Torque Constant†	N·m/A (lb·in·A)	0.247 (2.19)	0.35 (3.10)	0.37 (3.25)	0.51 (4.49)	0.50 (4.43)	0.524 (4.64)
Moment of Inertia $J_M(=GD^2/4)$	kg·m ² ×10 ⁻⁴ (lb·in·s ² ×10 ⁻⁹)	0.13 (0.11)	0.51 (0.45)	0.75 (0.67)	2.85 (2.53)	3.3 (2.88)	5.74 (5.09)
Power Rate*	kW/s	18.5	18.9	28.9	21	74	167
Inertia Time Constant†	ms	1.8	2.2	1.8	1.9	0.7	0.4
Inductive Time Constant†	ms	1.5	2.7	3.1	6.2	13	26

* Values when SERVOMOTOR is combined with SERVOPACK and the armature winding temperature is 100°C. Values shown are normal (TYP) values.

† Values when SERVOMOTOR is combined with SERVOPACK and the armature winding temperature is 20°C. Values shown are normal (TYP) values.

Notes:

1. □ in type designation is determined by output pulses (pulses/rev) of optical encoder as follows:

AC Servomotor Type USASEM-	02A, 03A, 05A		08A, 15A, 30A	
	Standard (pulses/rev)	E	1500	C
Optional (pulses/rev)	C	2500	E	1500
	F	1000	F	1000

2. There are two types of power supply units for brake.

- Input 100 VAC, output 90 VDC (DP 8401002-2)

- Input 200 VAC, output 90 VDC (DP 8401002-1)

For details, refer to Par. 8.5, "PERIPHERAL EQUIPMENT"

1.3.2 Torque-Speed Characteristics

• TYPE USASEM-02A

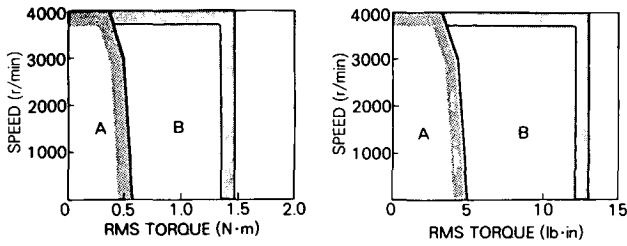

• TYPE USASEM-08A

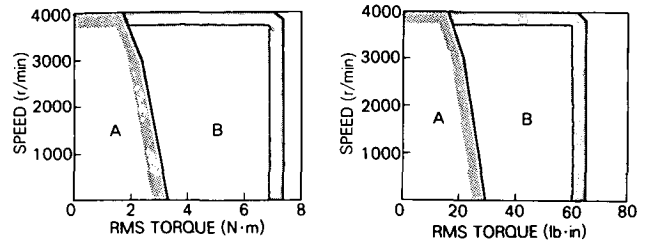

• TYPE USASEM-03A

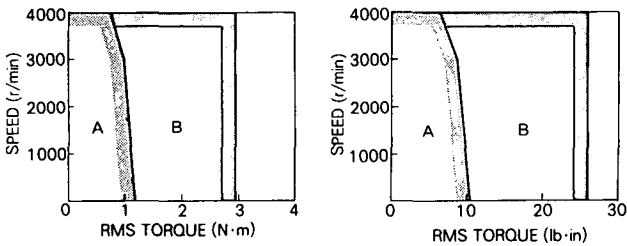

• TYPE USASEM-15A

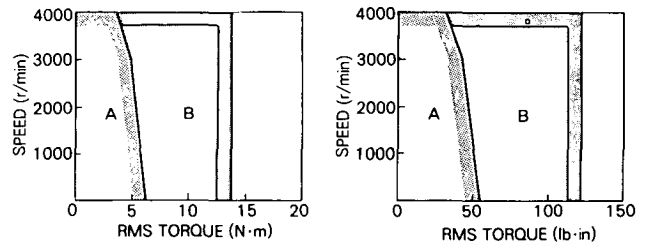

• TYPE USASEM-05A

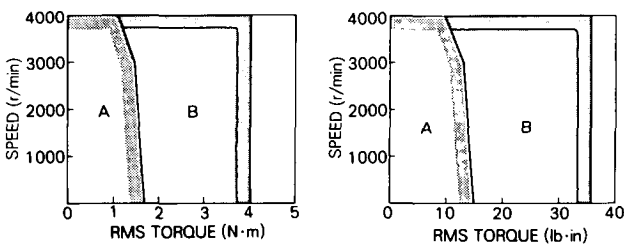

• TYPE USASEM-30A

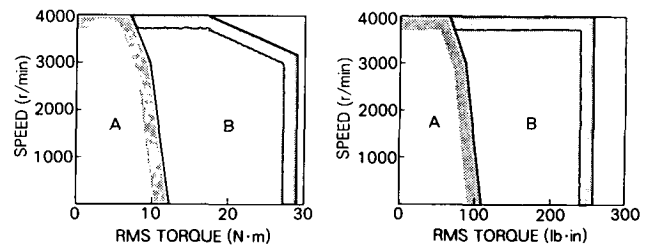

A: CONTINUOUS DUTY ZONE
 B: INTERMITTENT DUTY ZONE
 POWER SUPPLY: 200V

1.4 RATINGS AND SPECIFICATIONS OF SERVOPACK

Table 1.4 Ratings and Specifications of SERVOPACK

SERVOPACK Type CACR-		PR03BC	PR05BC	PR07BC	PR10BC	PR15BC	PR20BC	PR30BC	PR44BC		
Max Motor Output	kW (HP)	0.3 (0.4)	0.5 (0.67)	0.7 (0.94)	1.0 (1.34)	1.5 (2.01)	2.0 (2.7)	3.0 (4.1)	4.4 (6.0)		
M Series	Applicable Optical Encoder	A: 6000 pulses/rev (B: 5000 pulses/rev, D: 4000 pulses/rev)									
	AC SERVOMOTOR	Type USAMED-	03MA	—	06MA	09MA	12MA	20MA	30MA	44MA	
		Output kW (HP)	0.3 (0.4)	—	0.6 (0.8)	0.9 (1.2)	1.2 (1.2)	3.0 (2.7)	3.0 (4.1)	4.4 (6.0)	
		Rated Speed r/min	1000								
	SERVOPACK Type CACR-	PR03BC3AM	—	PR07BC3AM	PR10BC3AM	PR15BC3AM	PR20BC3AM	PR30BC3AM	PR44BC3AM		
	Continuous Output Current Arms	3.0	—	5.8	7.6	11.7	18.8	26.0	33.0		
Max Output Current Arms	7.3	—	13.9	16.6	28.0	42.0	56.5	70.0			
Allowable $J_L (=GD_L^2/4)$	$kg \cdot m^2 \times 10^{-4}$ ($lb \cdot in \cdot s^2 \times 10^{-3}$)	67.5 (60)	—	121.5 (107.5)	183.5 (162.5)	334 (296)	550 (486)	715 (633.5)	1200 (1063)		
F Series	Applicable Optical Encoder	A: 6000 pulses/rev (B: 5000 pulses/rev, D: 4000 pulses/rev)									
	AC SERVOMOTOR	Type USAFED-	02FA	03FA	05FA	—	09FA	13FA	20FA	30FA	44FA
		Output kW (HP)	0.15 (0.2)	0.3 (0.4)	0.45 (0.6)	—	0.85 (1.2)	1.3 (1.8)	1.8 (2.4)	2.9 (3.9)	4.4 (6.0)
		Rated Speed r/min	1500								
	SERVOPACK Type CACR-	PR03BC3AF	PR05BC3AF	—	PR10BC3AF	PR15BC3AF	PR20BC3AF	PR30BC3AF	PR44BC3AF		
	Continuous Output Current Arms	3.0	3.0	3.8	—	6.2	9.7	15.0	20.0	30.0	
Max Output Current Arms	8.5	8.5	11.0	—	17.0	27.6	42.0	56.5	77.0		
Allowable $J_L (=GD_L^2/4)$	$kg \cdot m^2 \times 10^{-4}$ ($lb \cdot in \cdot s^2 \times 10^{-3}$)	6.5 (5.75)	10.3 (9)	67.5 (60)	—	121.5 (107.5)	183.5 (162.5)	334 (296)	550 (486)	715 (633.5)	
S Series	Applicable Optical Encoder	C: 2500 pulses (E: 1500 pulses/rev, F: 1000 pulses/rev)									
	AC SERVOMOTOR	Type USASEM-	02AE	03AE	05AE	—	08AC	15AC	—	30AC	—
		Output kW (HP)	0.16 (0.2)	0.3 (0.4)	0.46 (0.6)	—	0.77 (1.1)	1.54 (2.1)	—	3.08 (4.2)	—
		Rated Speed r/min	3000								
	SERVOPACK Type CACR-	PR03BC3ES-Y4†	PR03BC3ES	PR05BC3ES	—	PR10BC3CS	PR15BC3CS	—	PR30BC3CS	—	
	Continuous Output Current Arms	2.1	3.0	4.3	—	5.3	10.4	—	19.9	—	
Max Output Current Arms	6.0	8.5	11.0	—	15.6	28.0	—	56.5	—		
Allowable $J_L (=GD_L^2/4)$	$kg \cdot m^2 \times 10^{-4}$ ($lb \cdot in \cdot s^2 \times 10^{-3}$)	0.65 (0.55)	2.55 (2.25)	3.75 (3.35)	—	14.25 (12.65)	16.5 (14.4)	—	28.7 (25.45)	—	
Basic Specifications	Power Supply	Main Circuit*	Three-phase 200 to 230 VAC $\pm 10\%$ 50/60 Hz								
		Control Circuit	Single-phase 200 to 230 VAC $\pm 10\%$ 50/60 Hz								
	Control Method	Transistorized PWM Control									
	Feedback	Optical encoder (A: 6000 pulses/rev, B: 5000 pulses/rev, C: 2500 pulses/rev, D: 4000 pulses/rev, E: 1500 pulses/rev, F: 1000 pulses/rev)									
	Ambient Temperature †	0 to +55°C									
	Storage Temperature	-20°C to +85°C									
	Ambient and Storage Humidity	90% or less (non-condensing)									
	Mounting Structure	Rack mounted									
Approx Mass	kg (lb)	7.0 (16)	7.0 (16)	7.0 (16)	7.0 (16)	7.0 (16)	12.5 (28)	12.5 (28)	12.5 (28)		
I/O Signal	Reference Pulse	Sign + pulse train input, +12V/+5V level selection available (CW/CCW pulse train input available)									
	Reference Pulse Frequency	fin: 0 to 100 kpps max									
	Control Signal	Servo ON, error counter clear, reference pulse block (reference pulse input selection), P drive, alarm reset, forward/reverse run stop.									
	Output Signal	Encoder (A, B and C phase) pulse, positioning completion, error counter overflow, servo ready, servo alarm, MCCB trip, overload, TG ON.									
Built-in Functions	Protection	Overvoltage, overload, overcurrent, overrun, open phase detection, MCCB trip, heatsink overheat, undervoltage, A/D error, regeneration trouble, CPU error, overflow.									
	Indication	Power supply, reference input, alarm, status, lag pulse, encoder (A, B and C phase) pulse indications.									
	Dynamic Brake	Built-in (non-contact dynamic brake)									
	Regenerative Resistor	Built-in									
	Applicable Load Inertia †	Up to 5 times motor inertia									
Monitor Output	Torque monitor: 3.0V $\pm 10\%$ at rated r/min Speed monitor: 4.0V $\pm 5\%$ at 1000r/min. (M, F series), 2.0V $\pm 5\%$ at 1000r/min (S series)										

* Supply voltage should not exceed 230 V + 10% (253 V). If the voltage should exceed this value, a step down transformer is required.

† When load inertia (GD^2) exceeds applicable range, be sure to refer to Par. 6.10.2, "Load Inertia."

† When housed in a panel, the inside temperature must not exceed ambient temperature range.

2. TYPE DESIGNATION

• AC SERVOMOTOR

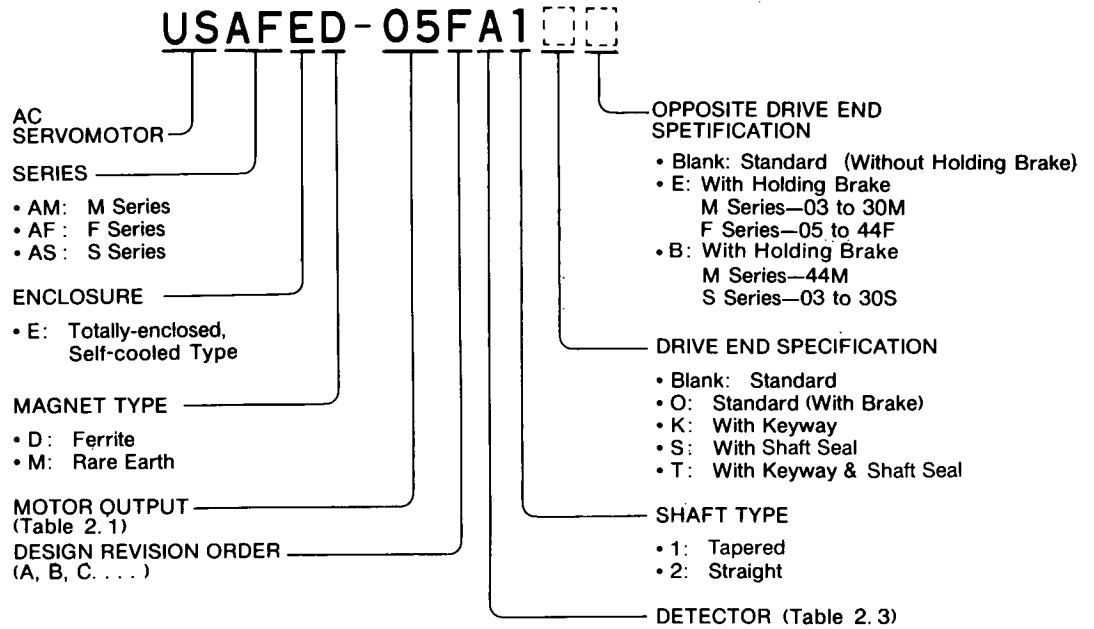

• SERVOPACK

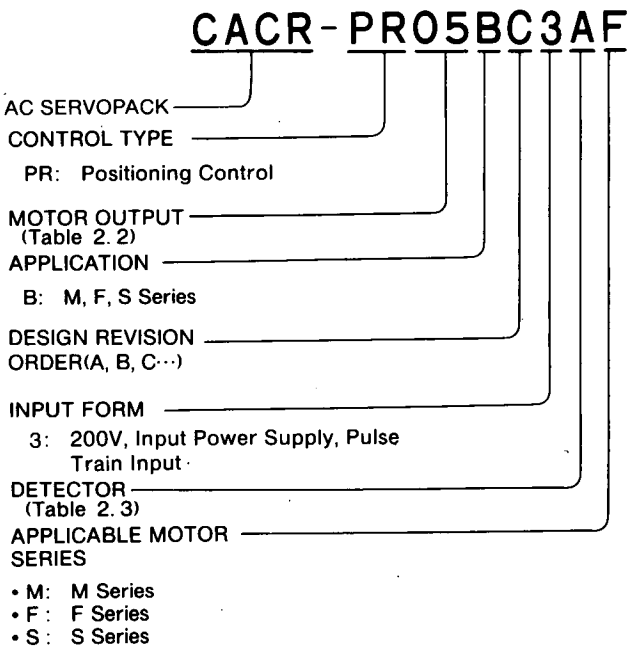

Table 2.1

	Motor Output		
	M Series	F Series	S Series
02	—	0.15kW(0.2HP)	0.15kW(0.2HP)
03	0.3kW(0.4HP)	0.3kW(0.4HP)	0.3kW(0.4HP)
05	—	0.45kW(0.6HP)	0.46kW(0.6HP)
06	0.6kW(0.8HP)	—	—
08	—	—	0.77kW(1.1HP)
09	0.9kW(1.2HP)	0.85kW(1.2HP)	—
12	1.2kW(1.6HP)	—	—
13	—	1.3kW(1.8HP)	—
15	—	—	1.5kW(2.1HP)
20	2.0kW(2.7HP)	1.8kW(2.4HP)	—
30	3.0kW(4.1HP)	2.9kW(3.9HP)	3.0kW(4.2HP)
44	4.4kW(6.0HP)	4.4kW(6.0HP)	—

Table 2.2

	Motor Output		
	M Series	F Series	S Series
03	0.3kW(0.4HP)	0.15kW(0.2HP) 0.3kW(0.4HP)	0.15kW(0.2HP) 0.3kW(0.4HP)
05	—	0.45kW(0.6HP)	0.46kW(0.6HP)
07	0.6kW(0.8HP)	—	—
10	0.9kW(1.2HP)	0.85kW(1.2HP)	0.77kW(1.1HP)
15	1.2kW(1.6HP)	1.3kW(1.8HP)	1.5kW(2.1HP)
20	2.0kW(2.7HP)	1.8kW(2.4HP)	—
30	3.0kW(4.1HP)	2.9kW(3.9HP)	3.0kW(4.2HP)
44	4.4kW(6.0HP)	4.4kW(6.0HP)	—



Table 2.3

Models	Standard pulses/rev		Optional pulses/rev			Remarks	
	A	6000	B	5000	D		4000
M Series	A	6000	B	5000	D	4000	—
F Series	A	6000	B	5000	D	4000	—
S Series	E	1500	C	2500	F	1000	02A, 03A, 05A
	C	2500	E	1500	F	1000	08A, 15A, 30A



3. LIST OF STANDARD COMBINATION

Table 3.1 Combination of SERVOPACK, AC SERVOMOTORS and Associated Units



• M SERIES

SERVOPACK Type CACR-	AC SERVOMOTOR		Power Capacity* per SERVOPACK kVA	Current Capacity per MCCB or Fuse A	Applicable Noise Filter	Recommended Noise Filter †		Power ON/OFF Switch
	Type	Optical Encoder pulses/rev				Type	Specifications	
PR03BC3AM	USAMED-03MA1	6000	0.65	5	 Good	LF- 305	3-phase 200 VAC class. 5 A	Yaskawa type HI-15E ₂ rated 30 A or equivalent
PR03BC3BM	USAMED-03MB1	5000						
PR03BC3DM	USAMED-03MD1	4000						
PR07BC3AM	USAMED-06MA1	6000	1.5	8		LF- 310	3-phase 200 VAC class. 10 A	
PR07BC3BM	USAMED-06MB1	5000						
PR07BC3DM	USAMED-06MD1	4000						
PR10BC3AM	USAMED-09MA2	6000	2.1	8		LF- 315	3-phase 200 VAC class. 15 A	
PR10BC3BM	USAMED-09MB2	5000						
PR10BC3DM	USAMED-09MD2	4000						
PR15BC3AM	USAMED-12MA2	6000	3.1	10		LF- 315	3-phase 200 VAC class. 15 A	
PR15BC3BM	USAMED-12MB2	5000						
PR15BC3DM	USAMED-12MD2	4000						
PR20BC3AM	USAMED-20MA2	6000	4.1	12	LF- 320	3-phase 200 VAC class. 20 A		
PR20BC3BM	USAMED-20MB2	5000						
PR20BC3DM	USAMED-20MD2	4000						
PR30BC3AM	USAMED-30MA2	6000	6.0	18	 Poor	LF- 330	3-phase 200 VAC class. 30 A	Yaskawa type HI-18E rated 35 A or equivalent
PR30BC3BM	USAMED-30MB2	5000						
PR30BC3DM	USAMED-30MD2	4000						
PR44BC3AM	USAMED-44MA2	6000	8.0	24	LF- 340	3-phase 200 VAC class. 40 A		
PR44BC3BM	USAMED-44MB2	5000						
PR44BC3DM	USAMED-44MD2	4000						

• F SERIES

PR03BC3AF	USAFED-02FA1	6000	1.1	5	 Good	LF- 305	3-phase 200 VAC class. 5 A	Yaskawa HI-15E ₂ rated 30 A or equivalent
PR03BC3BF	USAFED-02FB1	5000						
PR03BC3DF	USAFED-02FD1	4000						
PR03BC3AF	USAFED-03FA1	6000						
PR03BC3BF	USAFED-03FB1	5000						
PR03BC3DF	USAFED-03FD1	4000						
PR05BC3AF	USAFED-05FA1	6000						
PR05BC3BF	USAFED-05FB1	5000						
PR05BC3DF	USAFED-05FD1	4000						
PR10BC3AF	USAFED-09FA1	6000						
PR10BC3BF	USAFED-09FB1	5000	2.1	8	LF- 315	3-phase 200 VAC class. 15 A		
PR10BC3DF	USAFED-09FD1	4000						
PR15BC3AF	USAFED-13FA2	6000						
PR15BC3BF	USAFED-13FB2	5000	3.1	10	LF- 315	3-phase 200 VAC class. 15 A		
PR15BC3DF	USAFED-13FD2	4000						
PR20BC3AF	USAFED-20FA2	6000						
PR20BC3BF	USAFED-20FB2	5000	4.1	12	LF- 320	3-phase 200 VAC class. 20 A		
PR20BC3DF	USAFED-20FD2	4000						
PR30BC3AF	USAFED-30FA2	6000						
PR30BC3BF	USAFED-30FB2	5000	6.0	18	 Poor	LF- 330	3-phase 200 VAC class. 30 A	Yaskawa type HI-18E rated 35 A or equivalent
PR30BC3DF	USAFED-30FD2	4000						
PR44BC3AF	USAFED-44FA2	6000						
PR44BC3BF	USAFED-44FB2	5000	8.0	24	LF- 340	3-phase 200 VAC class. 40 A		
PR44BC3DF	USAFED-44FD2	4000						

• S SERIES

PR03BC3CS-Y41	USASEM-02AC2	2500	0.65	5	 Good	LF- 305	3-phase 200 VAC class. 5 A	Yaskawa type HI-15E ₂ rated 30 A or equivalent
PR03BC3ES-Y41	USASEM-02AE2	1500						
PR03BC3FS-Y41	USASEM-02AF2	1000						
PR03BC3CS	USASEM-03AC2	2500						
PR03BC3ES	USASEM-03AE2	1500						
PR03BC3FS	USASEM-03AF2	1000						
PR05BC3CS	USASEM-05AC2	2500	1.1	5		LF- 305	3-phase 200 VAC class. 5 A	
PR05BC3ES	USASEM-05AE2	1500						
PR05BC3FS	USASEM-05AF2	1000						
PR10BC3CS	USASEM-08AC1	2500	2.1	8		LF- 315	3-phase 200 VAC class. 15 A	
PR10BC3ES	USASEM-08AE1	1500						
PR10BC3FS	USASEM-08AF1	1000						
PR15BC3CS	USASEM-15AC1	2500	3.1	10	 Poor	LF- 315	3-phase 200 VAC class. 15 A	
PR15BC3ES	USASEM-15AE1	1500						
PR15BC3FS	USASEM-15AF1	1000						
PR30BC3CS	USASEM-30AC1	2500	6.0	18	LF- 330	3-phase 200 VAC class. 30 A	Yaskawa type HI-18E rated 35 A or equivalent	
PR30BC3ES	USASEM-30AE1	1500						
PR30BC3FS	USASEM-30AF1	1000						

*Values at rated load.

†Made by Tokin Corp.

Table 3.2 Specifications of AC SERVOMOTORS and Detectors

• M SERIES

SERVOPACK Type CACR-	AC SERVOMOTOR						Detector			
	Type	Optical Encoder pulses/rev	Receptacle Type	L-type Plug	Straight Plug	Cable Clamp	Receptacle Type	L-type Plug	Straight Plug	Cable Clamp
PR03BC3AM	USAMED-03MA1	6000	MS 3102A18 -10P	MS 3108B18 -10S	MS 3106B18 -10S	MS 3057 -10A	MS 3102A20 -29P	MS 3108B20 -29S	MS 3106B20 -29S	MS 3057 -12A
PR03BC3BM	USAMED-03MB1	5000								
PR03BC3DM	USAMED-03MD1	4000								
PR07BC3AM	USAMED-06MA1	6000								
PR07BC3BM	USAMED-06MB1	5000								
PR07BC3DM	USAMED-06MD1	4000								
PR10BC3AM	USAMED-09MA2	6000								
PR10BC3BM	USAMED-09MB2	5000								
PR10BC3DM	USAMED-09MD2	4000								
PR15BC3AM	USAMED-12MA2	6000								
PR15BC3BM	USAMED-12MB2	5000								
PR15BC3DM	USAMED-12MD2	4000								
PR20BC3AM	USAMED-20MA2	6000								
PR20BC3BM	USAMED-20MB2	5000								
PR20BC3DM	USAMED-20MD2	4000								
PR30BC3AM	USAMED-30MA2	6000								
PR30BC3BM	USAMED-30MB2	5000								
PR30BC3DM	USAMED-30MD2	4000								
PR44BC3AM	USAMED-44MA2	6000	MS 3102A32 -17P	MS 3108B32 -17S	MS 3106B32 -17S	MS 3057 -20A	MS 3102A20 -29P	MS 3108B20 -29S	MS 3106B20 -29S	MS 3057 -12A
PR44BC3BM	USAMED-44MB2	5000								
PR44BC3DM	USAMED-44MD2	4000								

• F SERIES

PR03BC3AF	USAFED-02FA1	6000	MS 3102A14S -2P	MS 3108B14S -2S	MS 3106B14S -2S	MS 3057 -6A	MS 3102A20 -29P	MS 3108B20 -29S	MS 3106B20 -29S	MS 3057 -12A
PR03BC3BF	USAFED-02FB1	5000								
PR03BC3DF	USAFED-02FD1	4000								
PR03BC3AF	USAFED-03FA1	6000								
PR03BC3BF	USAFED-03FB1	5000								
PR03BC3DF	USAFED-03FD1	4000								
PR05BC3AF	USAFED-05FA1	6000	MS 3102A18 -10P	MS 3108B18 -10S	MS 3106B18 -10S	MS 3057 -10A	MS 3102A20 -29P	MS 3108B20 -29S	MS 3106B20 -29S	MS 3057 -12A
PR05BC3BF	USAFED-05FB1	5000								
PR05BC3DF	USAFED-05FD1	4000								
PR10BC3AF	USAFED-09FA1	6000								
PR10BC3BF	USAFED-09FB1	5000								
PR10BC3DF	USAFED-09FD1	4000								
PR15BC3AF	USAFED-13FA2	6000	MS 3102A22 -22P	MS 3108B22 -22S	MS 3106B22 -22S	MS 3057 -12A	MS 3102A20 -29P	MS 3108B20 -29S	MS 3106B20 -29S	MS 3057 -12A
PR15BC3BF	USAFED-13FB2	5000								
PR15BC3DF	USAFED-13FD2	4000								
PR20BC3AF	USAFED-20FA2	6000								
PR20BC3BF	USAFED-20FB2	5000								
PR20BC3DF	USAFED-20FD2	4000								
PR30BC3AF	USAFED-30FA2	6000	MS 3102A22 -22P	MS 3108B22 -22S	MS 3106B22 -22S	MS 3057 -12A	MS 3102A20 -29P	MS 3108B20 -29S	MS 3106B20 -29S	MS 3057 -12A
PR30BC3BF	USAFED-30FB2	5000								
PR30BC3DF	USAFED-30FD2	4000								
PR44BC3AF	USAFED-44FA2	6000								
PR44BC3BF	USAFED-44FB2	5000								
PR44BC3DF	USAFED-44FD2	4000								

• S SERIES

PR03BC3CS-Y41	USASEM-02AC2	2500	MS 3102A18 -10P	MS 3108B18 -10S	-	MS 3057 -10A	MS 3102A20 -29P	MS 3108B20 -29S	-	MS 3057 -12A
PR03BC3ES-Y41	USASEM-02AE2	1500								
PR03BC3FS-Y41	USASEM-02AF2	1000								
PR03BC3CS	USASEM-03AC2	2500								
PR03BC3ES	USASEM-03AE2	1500								
PR03BC3FS	USASEM-03AF2	1000								
PR05BC3CS	USASEM-05AC2	2500								
PR05BC3ES	USASEM-05AE2	1500								
PR05BC3FS	USASEM-05AF2	1000								
PR10BC3CS	USASEM-08AC1	2500								
PR10BC3ES	USASEM-08AE1	1500								
PR10BC3FS	USASEM-08AF1	1000								
PR15BC3CS	USASEM-15AC1	2500								
PR15BC3ES	USASEM-15AE1	1500								
PR15BC3FS	USASEM-15AF1	1000								
PR30BC3CS	USASEM-30AC1	2500								
PR30BC3ES	USASEM-30AE1	1500								
PR30BC3FS	USASEM-30AF1	1000								

Note: When plugs or clamps are required, contact your YASKAWA representative. The following connections are provided: soldered type (type MS) and solderless type (type JA).

Table 3.3 Specifications of Holding Brake

• M SERIES

SERVOPACK Type CACR-	AC SERVOMOTOR		Holding Brake			
	Type	Optical Encoder pulses/rev	Receptacle Type	L-type Plug	Straight Plug	Cable Clamp
PR03BC3AM	USAMED-03MA1	6000	MS3102A20 -15P	MS3108B20 -15S	MS3106B20 -15S	MS3057 -12A
PR03BC3BM	USAMED-03MB1	5000				
PR03BC3DM	USAMED-03MD1	4000				
PR07BC3AM	USAMED-06MA1	6000				
PR07BC3BM	USAMED-06MB1	5000				
PR07BC3DM	USAMED-06MD1	4000				
PR10BC3AM	USAMED-09MA2	6000				
PR10BC3BM	USAMED-09MB2	5000				
PR10BC3DM	USAMED-09MD2	4000				
PR15BC3AM	USAMED-12MA2	6000				
PR15BC3BM	USAMED-12MB2	5000	MS3102A24 -10P	MS3108B24 -10S	MS3106B24 -10S	MS3057 -16A
PR15BC3DM	USAMED-12MD2	4000				
PR20BC3AM	USAMED-20MA2	6000				
PR20BC3BM	USAMED-20MB2	5000				
PR20BC3DM	USAMED-20MD2	4000				
PR30BC3AM	USAMED-30MA2	6000				
PR30BC3BM	USAMED-30MB2	5000				
PR30BC3DM	USAMED-30MD2	4000				
PR44BC3AM	USAMED-44MA2	6000				
PR44BC3BM	USAMED-44MB2	5000				
PR44BC3DM	USAMED-44MD2	4000	-	-	-	-

• F SERIES

PR03BC3AF	USAFED-02FA1	6000	MS3102A14S -6P	MS3108B14S -6S	MS3106B14S -6S	MC3057 -6A
PR03BC3BF	USAFED-02FB1	5000				
PR03BC3DF	USAFED-02FD1	4000				
PR03BC3AF	USAFED-03FA1	6000				
PR03BC3BF	USAFED-03FB1	5000				
PR03BC3DF	USAFED-03FD1	4000				
PR05BC3AF	USAFED-05FA1	6000	MS3102A20 -15P	MS3108B20 -15S	MS3106B20 -15S	MS3057 -12A
PR05BC3BF	USAFED-05FB1	5000				
PR05BC3DF	USAFED-05FD1	4000				
PR10BC3AF	USAFED-09FA1	6000				
PR10BC3BF	USAFED-09FB1	5000				
PR10BC3DF	USAFED-09FD1	4000				
PR15BC3AF	USAFED-13FA2	6000				
PR15BC3BF	USAFED-13FB2	5000				
PR15BC3DF	USAFED-13FD2	4000				
PR20BC3AF	USAFED-20FA2	6000				
PR20BC3BF	USAFED-20FB2	5000				
PR20BC3DF	USAFED-20FD2	4000				
PR30BC3AF	USAFED-30FA2	6000				
PR30BC3BF	USAFED-30FB2	5000				
PR30BC3DF	USAFED-30FD2	4000				
PR44BC3AF	USAFED-44FA2	6000				
PR44BC3BF	USAFED-44FB2	5000				
PR44BC3DF	USAFED-44FD2	4000				

• S SERIES

PR03BC3CS-Y41	USASEM-02AC2	2500	MS3102A18 -12P	MS3108B18 -12S		MS3057 -10A
PR03BC3ES-Y41	USASEM-02AE2	1500				
PR03BC3FS-Y41	USASEM-02AF2	1000				
PR03BC3CS	USASEM-03AC2	2500				
PR03BC3ES	USASEM-03AE2	1500				
PR03BC3FS	USASEM-03AF2	1000				
PR05BC3CS	USASEM-05AC2	2500				
PR05BC3ES	USASEM-05AE2	1500				
PR05BC3FS	USASEM-05AF2	1000				
PR10BC3CS	USASEM-08AC1	2500				
PR10BC3ES	USASEM-08AE1	1500				
PR10BC3FS	USASEM-08AF1	1000				
PR15BC3CS	USASEM-15AC1	2500				
PR15BC3ES	USASEM-15AE1	1500				
PR15BC3FS	USASEM-15AF1	1000				
PR30BC3CS	USASEM-30AC1	2500				
PR30BC3ES	USASEM-30AE1	1500				
PR30BC3FS	USASEM-30AF1	1000				

4. CHARACTERISTICS

4.1 OVERLOAD CHARACTERISTICS

The overload protective circuit built in SERVOPACK prevents the motor and SERVOPACK from overloading and restricts the allowable conduction time of SERVOPACK. (See Fig. 4.1.)

The overload detection level is set precisely by the hot start conditions at an ambient temperature of 55°C and cannot be changed.

NOTE

Hot start is the overload characteristics when the SERVOPACK is running at the rated load and thermally saturated.

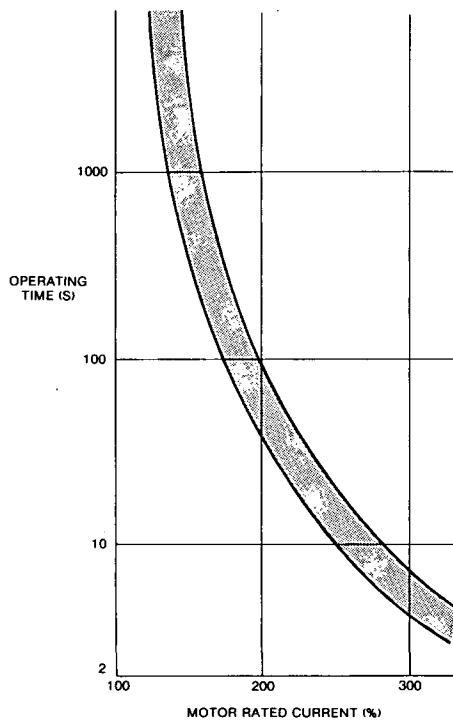

Fig. 4.1 Allowable Conduction Current of Servopack.

4.2 STARTING AND STOPPING TIME

The starting time and stopping time of SERVOMOTOR under a constant load is shown by the formula below. Viscous or friction torque of the motor is disregarded.

Starting Time:

$$t_r = 104.7 \times \frac{N_R (J_M + J_L)}{K_t \cdot I_R \cdot (\alpha - \beta)} \text{ (ms)} \quad \langle \text{Formula } 4-1 \rangle$$

Stopping Time:

$$t_f = 104.7 \times \frac{N_R (J_M + J_L)}{K_t \cdot I_R \cdot (\alpha + \beta)} \text{ (ms)} \quad \langle \text{Formula } 4-2 \rangle$$

Where,

N_R : Rated motor speed (r/min)

$J_M (= GD_M^2/4)$: Moment of motor inertia (kg·cm² = lb·in·s²×10⁻³)

$J_L (= GD_L^2/4)$: Moment of load inertia (kg·cm² = lb·in·s²×10⁻³)

K_t : Torque constant of motor (N·m/A = lb·in/A)

I_R : Motor rated current (A)

$\alpha = I_P / I_R$: Accel/decel current constant

I_P : Accel/decel current (Accel/decel current α times the motor rated current) (A)

$\beta = I_L / I_R$: Load current constant

I_L : Current equivalent to load torque (Load current β times the motor rated current) (A)

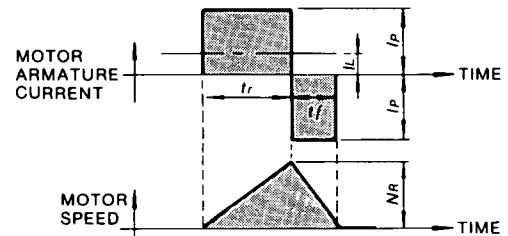

Fig. 4.2 Timing Chart of Motor Armature Current and Speed (Constant Load)

4.3 ALLOWABLE FREQUENCY OF OPERATION

The allowable frequency of operation is restricted by the SERVOMOTOR and SERVOPACK, and the conditions must be considered for satisfactory operation.

- Allowable frequency of operation restricted by the SERVOPACK

The allowable frequency of operation is restricted by the heat generated in the regenerative resistor in the SERVOPACK, and varies depending on the motor types, capacity, J_L , acceleration/deceleration current values, and motor speed. If the frequency of operation exceeds 60 times/min when $J_L = 0$ before the rated speed is reached, or if it exceeds $\frac{60}{m+1}$ cycles/min when $J_L = J_M \times m$, contact your YASKAWA representative.

- Allowable frequency of operation restricted by the Servomotor

The allowable frequency of operation varies depending on the load conditions, motor running time and the operating conditions. Typical examples are shown below. See Par. 4.2, "Starting and Stopping Time" for symbols.

- When the motor repeats rated-speed operation and being at standstill (Fig. 4.3).

Cycle time(T) should be determined so that RMS value of motor armature current is lower than the motor rated current:

$$T \geq \frac{I_P^2 (t_r + t_f) + I_L^2 t_s}{I_R^2} \text{ (s)}$$

Where cycle time (T) is determined, values I_p , t_r , t_f satisfying the formula above, should be specified.

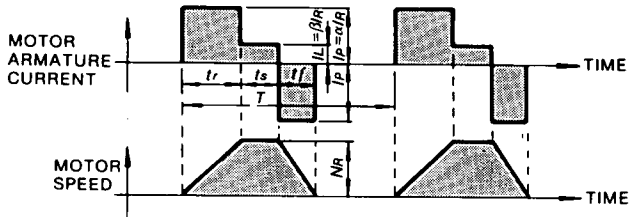

Fig. 4.3 Timing Chart of Motor Armature Current and Speed (Restricted by SERVOMOTOR)

- When the motor remains at standstill between cycles of acceleration and deceleration without continuous rated speed running (Fig. 4.4).

The timing chart of the motor armature current and speed is as shown in Fig. 4.4. The allowable frequency of operation "n" can be calculated as follows:

$$n = 286.5 \times \frac{Kt \cdot I_R}{N_R (J_M + J_L)} \left(\frac{1}{\alpha} - \frac{\beta^2}{\alpha^3} \right) \quad \text{(Formula 4-3)}$$

(times/min)

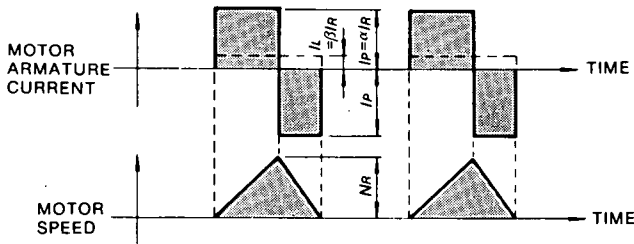

Fig. 4.4 Timing Chart of Motor Armature Current and Speed

(The motor remains at standstill between cycles of accel/decel) (without continuous rated speed running.)

- When the motor accelerates, runs at constant speed, and decelerates in a continuing cycle without being at standstill (Fig. 4.5).

The timing chart of the motor armature current and speed is as shown in Fig. 4.5. The allowable frequency of operation "n" can be calculated as follows.

$$n = 286.5 \times \frac{Kt \cdot I_R}{N_R (J_M + J_L)} \left(\frac{1}{\alpha} - \frac{\beta^2}{\alpha} \right) \quad \text{(Formula 4-4)}$$

(times/min)

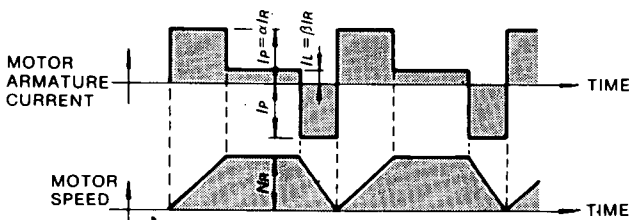

Fig. 4.5 Timing Chart of Motor Armature Current and Speed

(The motor accelerates, runs at constant speed, and decelerates in a continuing cycle without being at standstill.)

(Reference)

The formulas (4-1 to 4-5) are changed to the calculating method using the international system of units. For reference only, the traditional formulas are shown in Table 4.1.

Table 4.1

Formula	Traditional Formula
4-1	Starting time : $t_r = 26.8 \times 10^{-3} \times \frac{N_R (GD_M^2 + GD_L^2)}{Kt \cdot I_R (\alpha - \beta)}$ [ms]
4-2	Stopping time : $t_f = 26.8 \times 10^{-3} \times \frac{N_R (GD_M^2 + GD_L^2)}{Kt \cdot I_R (\alpha + \beta)}$ [ms]
	N_R : Rated motor speed (r/min) GD_M^2 : Moment of motor inertia ($\text{kg} \cdot \text{cm}^2 = \text{lb} \cdot \text{in} \cdot \text{s}^2 \times 10^{-3}$) GD_L^2 : Moment of load inertia ($\text{kg} \cdot \text{cm}^2 = \text{lb} \cdot \text{in} \cdot \text{s}^2 \times 10^{-3}$) Kt : Torque constant of motor ($\text{kg} \cdot \text{cm}/\text{A} = \text{lb} \cdot \text{in}/\text{A}$) I_R : Motor rated current (A) $\alpha = I_p/I_R$: Accel/decel current constant I_p : Accel/decel current (Accel/decel current α times the motor rated current) (A) $\beta = I_L/I_R$: Load current constant I_L : Current equivalent to load torque (Load current β times the motor rated current) (A)
4-3	$n = 1.12 \times 10^6 \times \frac{Kt \cdot I_R}{N_R (GD_M^2 + GD_L^2)} \times (1/\alpha - \beta^2/\alpha^3)$ [times/min]
4-4	$n = 1.12 \times 10^6 \times \frac{Kt \cdot I_R}{N_R (GD_M^2 + GD_L^2)} \times (1/\alpha - \beta^2/\alpha)$ [times/min]

4.4 MOTOR MECHANICAL CHARACTERISTICS

4.4.1 Mechanical Strength

AC SERVOMOTORS can carry up to 300% of the rated momentary maximum torque at output shaft.

4.4.2 Allowable Radial Load and Thrust Load

Tables 4.1 to 4.3 show allowable loads according to AC SERVOMOTOR types.

Table 4.1 M Series Allowable Radial Load and Thrust Load

Motor Type USAMED-	Allowable Radial Load* N (lb)	Allowable Thrust Load N (lb)
03MA1	490 (110)	98 (22)†
06MA1	490 (110)	98 (22)†
09MA2	686 (154)	343 (77)
12MA2	1470 (330)	490 (110)
20MA2	1470 (330)	490 (110)
30MA2	1470 (330)	490 (110)
44MA2	1764 (397)	588 (132)

Table 4.2 F Series Allowable Radial Load and Thrust Load

Motor Type USAFED-	Allowable Radial Load* N (lb)	Allowable Thrust Load N (lb)
02F	147 (33)	49 (11)†
03F	147 (33)	49 (11)†
05F	490 (110)	98 (22)†
09F	490 (110)	98 (22)†
13F	686 (154)	343 (77)
20F	1470 (331)	490 (110)
30F	1470 (331)	490 (110)
44F	1470 (331)	490 (110)

Table 4.3 S Series Allowable Radial Load and Thrust Load

Motor Type USASEM-	Allowable Radial Load* N (lb)	Allowable Thrust Load N (lb)
02A	78.4 (18)	39.2 (9)
03A	245 (55)	98 (22)
05A	245 (55)	98 (22)
08A	392 (88)	147 (33)
15A	490 (110)	147 (33)
30A	686 (154)	196 (44)

*Maximum values of the load applying to the shaft extension.

†Do not apply the exceeding load because motor cannot be rotated.

4.4.3 Mechanical Specifications (M, F and S series)

Table 4.4 Mechanical Specifications in mm

Accuracy (T.I.R.)†	Reference Diagram
Flange surface perpendicular to shaft (A)	
Flange diameter concentric to shaft (B)	
Shaft run out (C)	

†T.I.R. (Total Indicator Reading)

†Accuracy for motor type USAMED-44MA2.

4.4.4 Direction of Rotation

AC SERVOMOTORS rotate counterclockwise (CCW) when viewed from the drive end when motor and detector leads are connected as shown below.

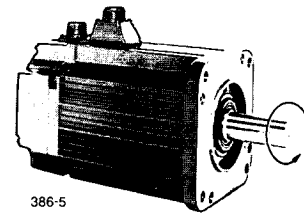
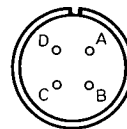

Fig. 4.6 AC SERVOMOTOR

(1) Connector Specifications for Standard SERVOMOTORS

(a) Motor receptacle

• M, F Series



A	Phase U
B	Phase V
C	Phase W
D	Frame ground

• S Series

(Type USASEM-02A)

Color of Lead	Applicable
Red	Phase U
White	Phase V
Blue	Phase W
Green	Frame ground

(Types USASEM-03A to 30A)

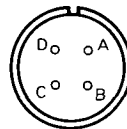

A	Phase U
B	Phase V
C	Phase W
D	Frame ground

(b) Detector receptacle

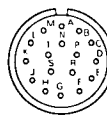

A	Channel A output	K	Channel U output
B	Channel \bar{A} output	L	Channel \bar{U} output
C	Channel B output	M	Channel V output
D	Channel \bar{B} output	N	Channel \bar{V} output
E	Channel Z output	P	Channel W output
F	Channel \bar{Z} output	R	Channel \bar{W} output
G	0V	S	—
H	+5VDC	T	—
J	Frame ground	—	—

(2) Connector Specifications for SERVOMOTOR with Brake

• M, F Series

(Types USAFED-05 to -44)

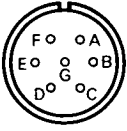

A	Phase U	E	Brake terminal
B	Phase V	F	
C	Phase W	G	—
D	Ground	—	—

• F Series

(Types USAFED-02 and -03)

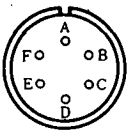

A	Phase U
B	Phase V
C	Phase W
D	Frame ground
E	Brake terminal
F	Brake terminal

• S Series

(Type USASEM-02A)

Color of Lead	Applicable	Color of Lead	Applicable
Red	Phase U	Black	Brake
White	Phase V	Black	
Blue	Phase W	Green	Frame Ground

(Types USASEM-03A, -05A)

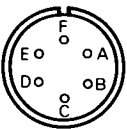

A	Phase U
B	Phase V
C	Phase W
D	Brake terminal
E	Brake terminal
F	Frame ground

(Types USASEM-08A to 30A)

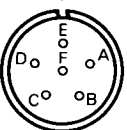

A	Phase U
B	Phase V
C	Phase W
D	Brake terminal
E	
F	Frame ground

4. 4. 5 Impact Resistance

When mounted horizontally and exposed to vertical shock impulses, the motor can withstand up to two impacts with impact acceleration of 50G (Fig. 4.7).

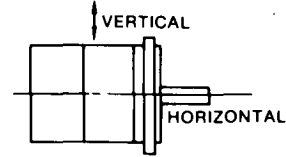

Fig. 4. 7 Impact Resistance

NOTE

A precision detector is mounted on the opposite-drive and of AC SERVOMOTOR. Care should be taken to protect the shaft from directly impacts that could damage the detector.

4. 4. 6 Vibration Resistance

When mounted horizontally, the motor can withstand vibration (vertical, lateral, axial) of 2.5G (Fig.4.8).

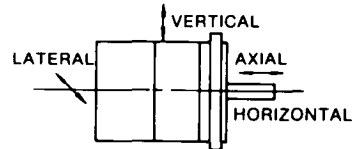

Fig. 4. 8 Vibration Resistance

4. 4. 7 Vibration Class

Vibration of the motor running at rated speed is 15 μm or below (Fig.4.9)

POSITION FOR CHECKING VIBRATION

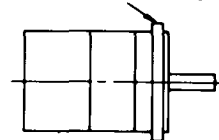

Fig. 4. 9 Vibration Checking

4. 4. 8 Holding Brake

Turn on/off according to Par. 6.12.2, "Use of SERVOMOTORS with Holding Magnetic Brake" since AC SERVOMOTORS with brake is used when the operation is held.

5. CONFIGURATION

5.1 CONNECTION DIAGRAM

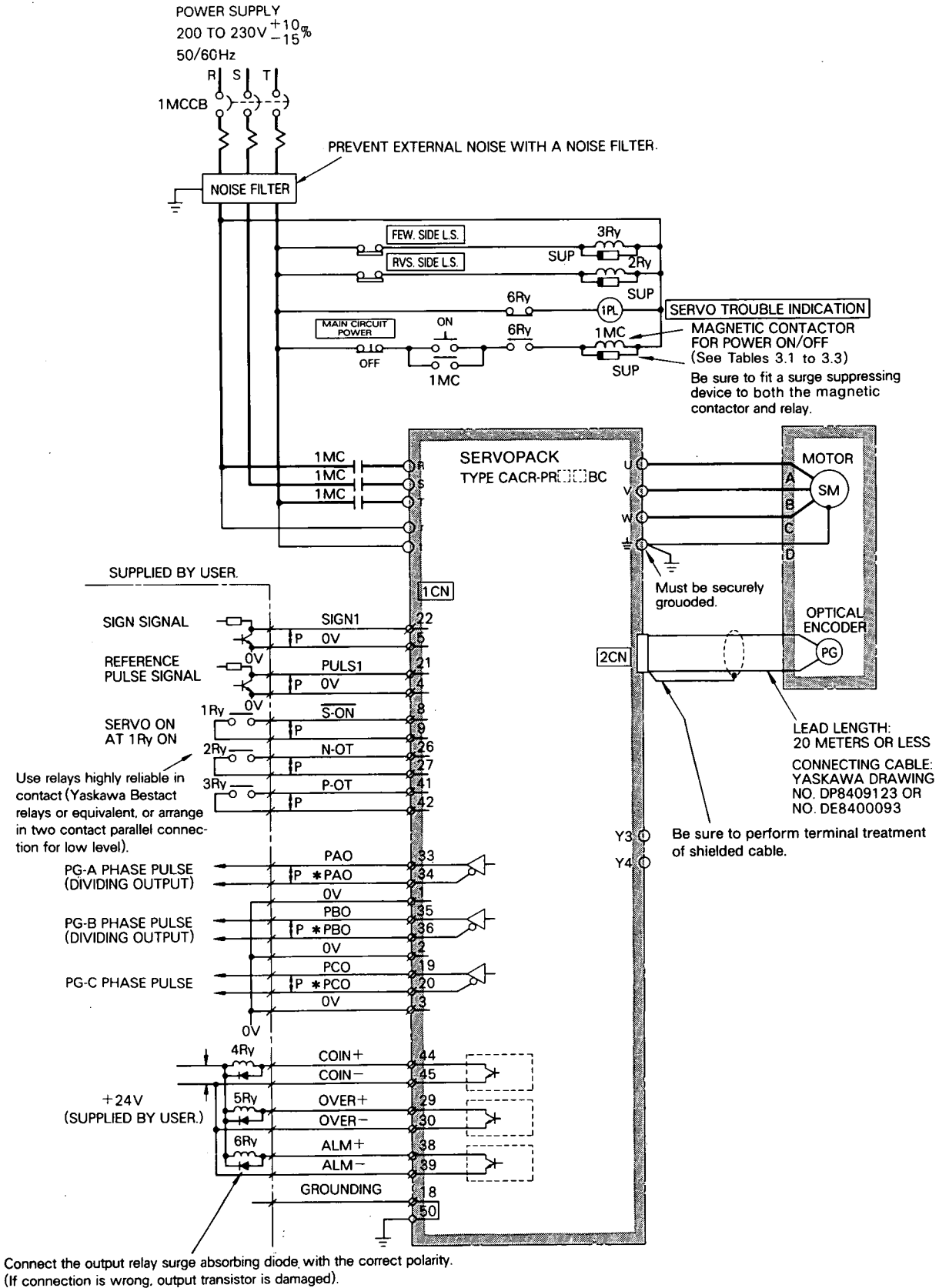

Fig. 5.1 Example of Connection Diagram of SERVOPACK with a SERVOMOTOR and Peripherals

5. 2 INTERNAL BLOCK DIAGRAM

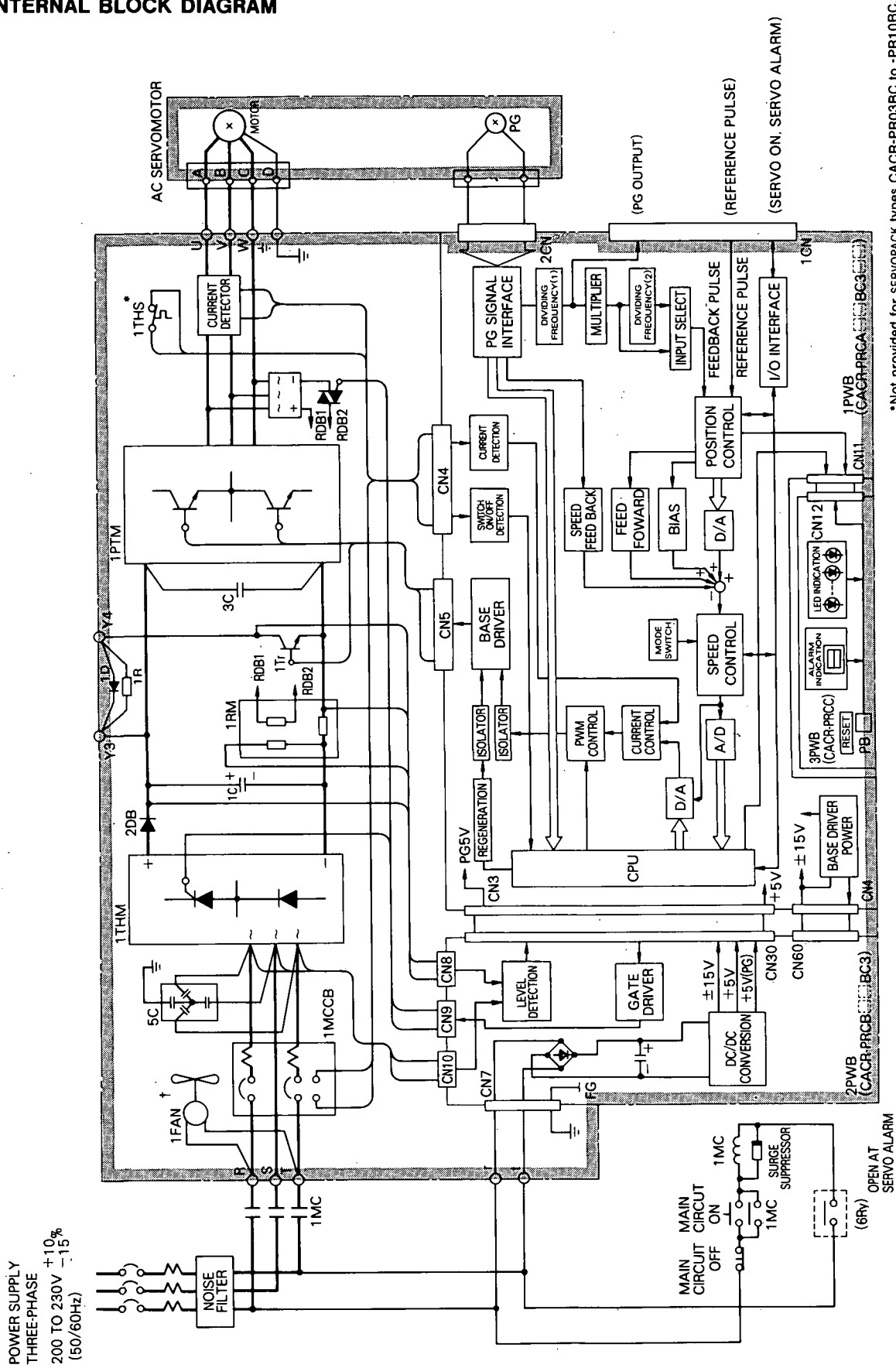

Fig. 5. 2 Internal Block Diagram of SERVOPACK

5.3 EXTERNAL TERMINALS

Table 5.1 shows the specifications of external terminals for SERVOPACK.

Table 5.1 External Terminals for SERVOPACK

Terminal Symbol	Name	Description
Ⓜ Ⓢ Ⓣ	Main-circuit AC input	Three-phase 200 to 230 VAC $\pm 10\%$, 50/60 Hz.
Ⓤ Ⓥ Ⓦ	Motor connection	Connects terminal Ⓤ to motor terminal A, Ⓥ to B and Ⓦ to C.
Ⓣ Ⓣ	Control power input	Single-phase 200 to 230 VAC $\pm 10\%$, 50/60 Hz
Ⓧ	Ground	Connects to motor terminal D. Must be securely grounded.
Ⓨ3 Ⓨ4	Regenerative resistor	External connection not normally required.

5.4 CONNECTOR TERMINAL (1CN) FOR I/O SIGNAL

5.4.1 Specifications of Applicable Receptacles

Table 5.2 Specifications of Applicable Receptacles for SERVOPACK I/O Signal

Connector Type* used in SERVOPACK	Applicable Receptacle Type			
	Manufacturer	Soldered Type	Caulking Type	Case
MR-50RMA (Right angle 50 P)	Honda Tsushin Co., Ltd.	MR-50F†	MRP-50F01	MR-50L†

*Use connector type MR-50RMA made by Honda Tsushin Co.
†Attached to SERVOPACK when shipping.

5.4.2 Connector 1CN Layout and Connection of SERVOPACK

The terminal layout of the SERVOPACK input/output signal connectors (1CN) is shown in Table 5.3. The external connection and external signal processing are shown in Fig. 5.3 on page 18.

Table 5.3 Connector 1 CN Layout of SERVOPACK

1	2	3	4	5	6	7	8	9	10	11	12	13	14	15	16	17	18
0V	0V	0V	0V	0V	0V	—	S-ON	0V	OL+	OL-	ALRES	INH	0V	TRQ-M	VTG-M	0V	FG
0V for PG Output Signal			0V for PULS	0V for PULS	0V for CL, INH	—	Servo ON Input	0V for S-ON	Overload Output		Alarm Reset Input	Ref. Pulse Block Input	0V for ALRES	Torque Ref. Monitor Output	Speed Monitor Output	0V for TRQ-M, VTG-M	Frame Ground (Interruption)
	19	20	21	22	23	24	25	26	27	28	29	30	31	32			
	PCO	*PCO	PULS1	SIGN1	CL	P-CON	0V	N-OT	0V	PULS2	OVER+	OVER-	TGON+	TGON-			
	PG Output Signal (Phase C)		First Ref. Pulse Input	First Ref. Sign Input	Clear Input	P Drive Input	0V for P-CON	Rvs. Inhb. Input	0V for N-OT	Second Ref. Pulse Input	Overflow Output		TGON Signal Output				
33	34	35	36	37	38	39	40	41	42	43	44	45	46	47	48	49	50
PAO	*PAO	PBO	*PBO	*PULS1	ALM+	ALM-	*SIGN1	P-OT	0V	SIGN2	COIN+	COIN-	S-RDY+	S-RDY-	MCB+	MCB-	FG
PG Signal Output (Phase A)		PG signal Output (Phase B)		Line Driver Input of PULS1	Servo Alarm Output		Line Driver Input of SIGN1	Fwd. Inhb. Input	0V for P-OT	Second Ref. Sign Input	Positioning Completion Output		Servo Ready Output		MCCB Trip Signal Output		Frame Ground (Interruption)

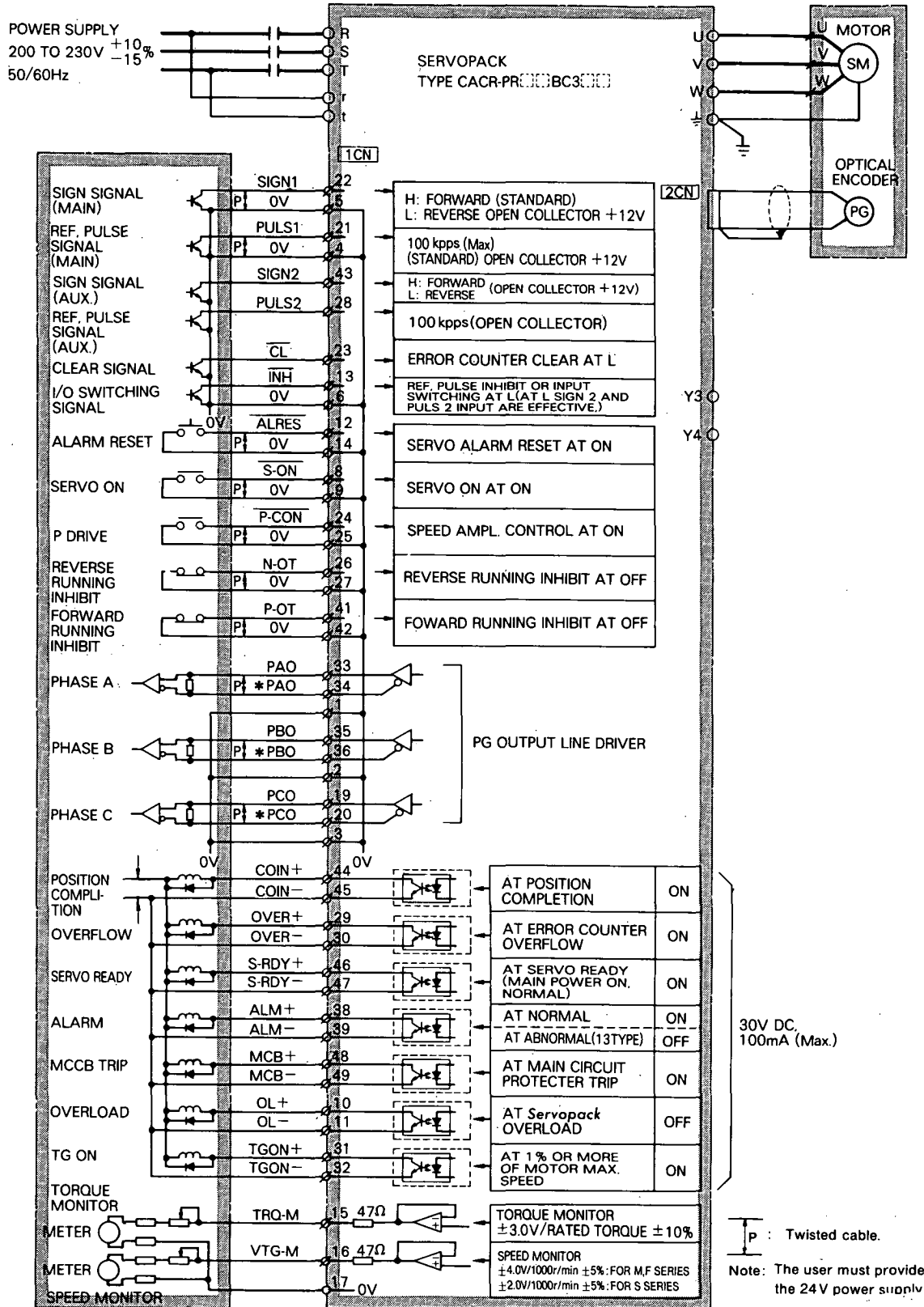

Fig. 5.3 I/O of Signals and Connector 1CN

5.4.3 I/O Signals of Connector 1CN

Table 5.4 Input Signals of Connector 1CN

Signal Name	Connector 1 CN No.	Function	Description
$\overline{S-ON}$	1CN-8	Servo ON	Upon inputting this signal, base block of main circuit transistor is released, and motor is servo locked, SERVOPACK is made ready to receive reference pulse input.
$\overline{P-CON}$	1CN-24	Speed amplifier proportional drive reference	Upon inputting this signal, control mode of speed amplifier is switched from PI (proportional-integral) drive to P(proportional) drive.
N-OT	1CN-26	Reverse running prohibit	In the case of linear drive, etc., connect limit switch signal according to the run direction. These signals are "closed" during normal run. When limit switch is tripped, it becomes "open."
P-OT	1CN-41	Forward running prohibit	
\overline{ALRES}	1CN-12	Alarm reset	This signal resets the alarm status. Check the alarm contents before this signal is turned ON.
SIGN 1	1CN-22	Reference sign input (main)	These signals are reference pulse inputs. The following input forms are available. • Sign + pulse train input. • CW/CCW pulse train input etc.
PULS 1	1CN-21	Reference pulse input (main)	
SIGN 2	1CN-43	Reference sign input (aux.)	These signals are auxiliary reference pulse inputs. The following input forms are available. • Sign + pulse train input. • CW/CCW pulse train input etc.
PULS 2	1CN-28	Reference pulse input (aux.)	
\overline{CL}	1CN-23	Clear	This signal is error counter clear input.
\overline{INH}	1CN-33	Reference pulse input switching	This signal makes the auxiliary reference pulse input effective by blocking of the main reference pulse input signal.

Table 5.5 Output Signals of Connector 1CN

Signal Name	Connector 1CN No.	Function	Description
\overline{COIN}	1CN-45(45)	Position completion	Turns ON when number of lag pulses in error counter reaches the setting value or less.
\overline{OVER}	1CN-29(30)	Overflow	Turns ON when lag pulses become double the number of lag pulses of the error counter setting bits.
ALM	1CN-38(39)	Servo alarm	Turns OFF when fault is detected. For details, refer to Table 6.11, "Fault Detection Function."
$\overline{S-RDY}$	1CN-46(47)	Servo ready	Turns ON when main power supply ON, and there are no servo alarm conditions.
\overline{MCB}	1CN-48(49)	MCCB trip	Turns ON when MCCB trips.
OL	1CN-10(11)	Overload detection	Turns OFF when overload is detected. Refer to Fig. 6.2 "Overload characteristics."
TGON	1CN-31(32)	Motor run detection	Turns ON when motor speed exceeds the following speeds: • M Series: 20r/min $\pm 10\%$ • F Series: 25r/min $\pm 10\%$ • S Series: 40r/min $\pm 10\%$
PAO	1CN-33	PG-phase A	Pulse after frequency division is output line driver(TI MC 3487). To be received by line receiver (TI 75175).
* PAO	1CN-34		
PBO	1CN-35	PG-phase B	
* PBO	1CN-36		
PCO	1CN-19	PG-phase C	
* PCO	1CN-20		
TRQ-M	1CN-15	Torque monitor	($\pm 3.0V/\text{rated torque}$) $\pm 10\%$, output voltage $\pm 9V$ max, output current 1 mA max
VTG-M	1CN-16	Speed monitor	M, F Series ($\pm 4.0V/1000r/\text{min}$) $\pm 5\%$. S Series ($\pm 2.0V/1000r/\text{min}$) $\pm 5\%$. output current 1 mA max

5.5 CONNECTOR TERMINAL (2CN) FOR OPTICAL ENCODER (PG) CONNECTION

5.5.1 Specifications of Applicable Receptacles and Cables (Table 5.6)

Table 5.6 Specifications of Applicable Receptacles and Cables

Connector Type* used in SERVOPACK	Applicable Receptacle Type				Connection Cable#
	Manufacturer	Soldered Type	Caulking Type	Case†	
MR-20RMA, right angle 20P	Honda Tsushin Co., Ltd.	MR-20F†	MRP-20F01	MR-20L†	DP8409123 or DE8400093

*Made by Honda Tsushin Co., Ltd.

†Attached to each applicable receptacle (soldered and caulking types).

‡Attached to SERVOPACK when shipping.

*The cables listed in Table 5.7 and available on request.

‡If required, purchase in units of standard length as shown in Table 5.7.

Table 5.7 Details of Specifications of Applicable Cables

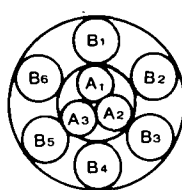
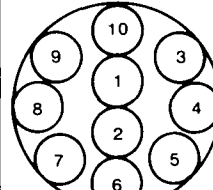
Connection	Soldered Type	Caulking Type																																					
Yaskawa Drawing No.	DP 8409123	DE 8400093																																					
Manufacturer	Fujikura Cable Co.																																						
Approx Specifications	Double, KQVV-SW AWG 22 × 3 C AWG 26 × 6 P	KQVV-SB AWG 26 × 10 P																																					
Internal Composition and Lead Color	For Soldered Type 	For Caulking Type 																																					
	<table border="1"> <tr><td>A₁</td><td>Red</td></tr> <tr><td>A₂</td><td>Black</td></tr> <tr><td>A₃</td><td>Green yellow</td></tr> <tr><td>B₁</td><td>Blue-White/blue</td></tr> <tr><td>B₂</td><td>Yellow-White/yellow</td></tr> <tr><td>B₃</td><td>Green-White/green</td></tr> <tr><td>B₄</td><td>Orange-White/orange</td></tr> <tr><td>B₅</td><td>Purple-White/purple</td></tr> <tr><td>B₆</td><td>Grey-White/grey</td></tr> </table>	A ₁	Red	A ₂	Black	A ₃	Green yellow	B ₁	Blue-White/blue	B ₂	Yellow-White/yellow	B ₃	Green-White/green	B ₄	Orange-White/orange	B ₅	Purple-White/purple	B ₆	Grey-White/grey	<table border="1"> <tr><td>1</td><td>Blue-White-</td></tr> <tr><td>2</td><td>Yellow-White</td></tr> <tr><td>3</td><td>Green-White</td></tr> <tr><td>4</td><td>Red-White</td></tr> <tr><td>5</td><td>Purple-White</td></tr> <tr><td>6</td><td>Blue-Brown</td></tr> <tr><td>7</td><td>Yellow-Brown</td></tr> <tr><td>8</td><td>Green-Brown</td></tr> <tr><td>9</td><td>Red-Brown</td></tr> <tr><td>10</td><td>Purple-Brown</td></tr> </table>	1	Blue-White-	2	Yellow-White	3	Green-White	4	Red-White	5	Purple-White	6	Blue-Brown	7	Yellow-Brown	8	Green-Brown	9	Red-Brown	10
A ₁	Red																																						
A ₂	Black																																						
A ₃	Green yellow																																						
B ₁	Blue-White/blue																																						
B ₂	Yellow-White/yellow																																						
B ₃	Green-White/green																																						
B ₄	Orange-White/orange																																						
B ₅	Purple-White/purple																																						
B ₆	Grey-White/grey																																						
1	Blue-White-																																						
2	Yellow-White																																						
3	Green-White																																						
4	Red-White																																						
5	Purple-White																																						
6	Blue-Brown																																						
7	Yellow-Brown																																						
8	Green-Brown																																						
9	Red-Brown																																						
10	Purple-Brown																																						
Yaskawa Standard Specifications	Standard lengths: 5m, 10m, 20m Terminal ends are not provided (with connectors).																																						

NOTE

1. When applicable cables listed in Table 5.7 are used, allowable wiring distance between SERVOPACK and motor is a maximum of 20 meters.
2. The cable applied for 50 m wiring distance is available on order (Yaskawa drawing No. DP8409179). If wiring distance is 20 m or more, contact your Yaskawa representative.

5.5.2 SERVOPACK Connector (2CN) Terminal Layout and Connection

The terminal layout for the SERVOPACK connectors (2CN) for connecting the optical encoder is shown in Table 5.8, and the connection method of 2CN and the optical encoder, in Figs. 5.4 and 5.5.

Table 5.8 Connector 2 CN Layout of SERVOPACK

1	2	3	4	5	6	7
PG0V	PG0V	PG0V	PG5V	PG5V	PG5V	DIR
	8	9	10	11	12	13
	PU	*PU	PV	*PV	PW	*PW
14	15	16	17	18	19	20
PC	*PC	PA	*PA	PB	*PB	FG

5.5.2 SERVOPACK Connector (2CN) Terminal Layout and Connection (Cont'd)

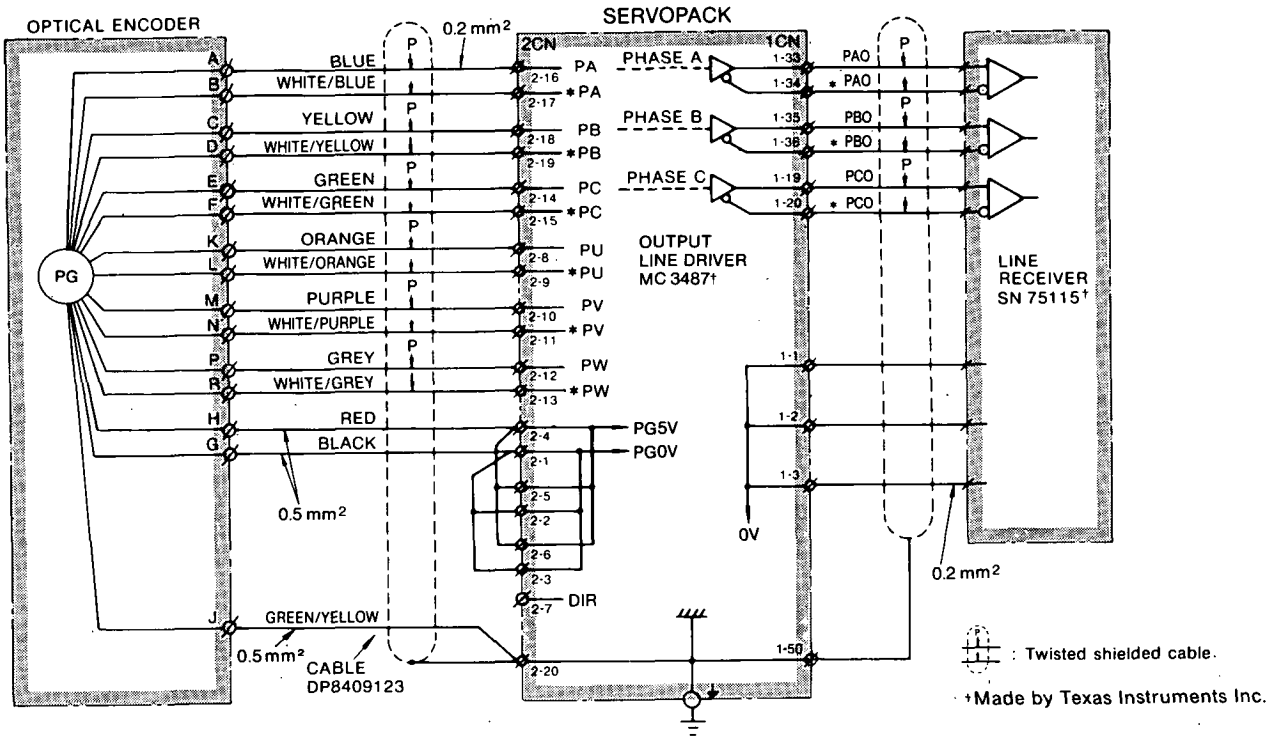

Note: Connector specifications of optical encoders are as follows.
 Connector — Type MS3102A20-29P (Receptacle)
 Accessory (not attached) — Type MS3108B20-29S (Angle plug)
 Type MS3057-12A (Cable clamp)

Fig. 5.4 Soldered Type Connector 2CN Connection and 1CN Output Processing (when using Connection Cable DP8409123)

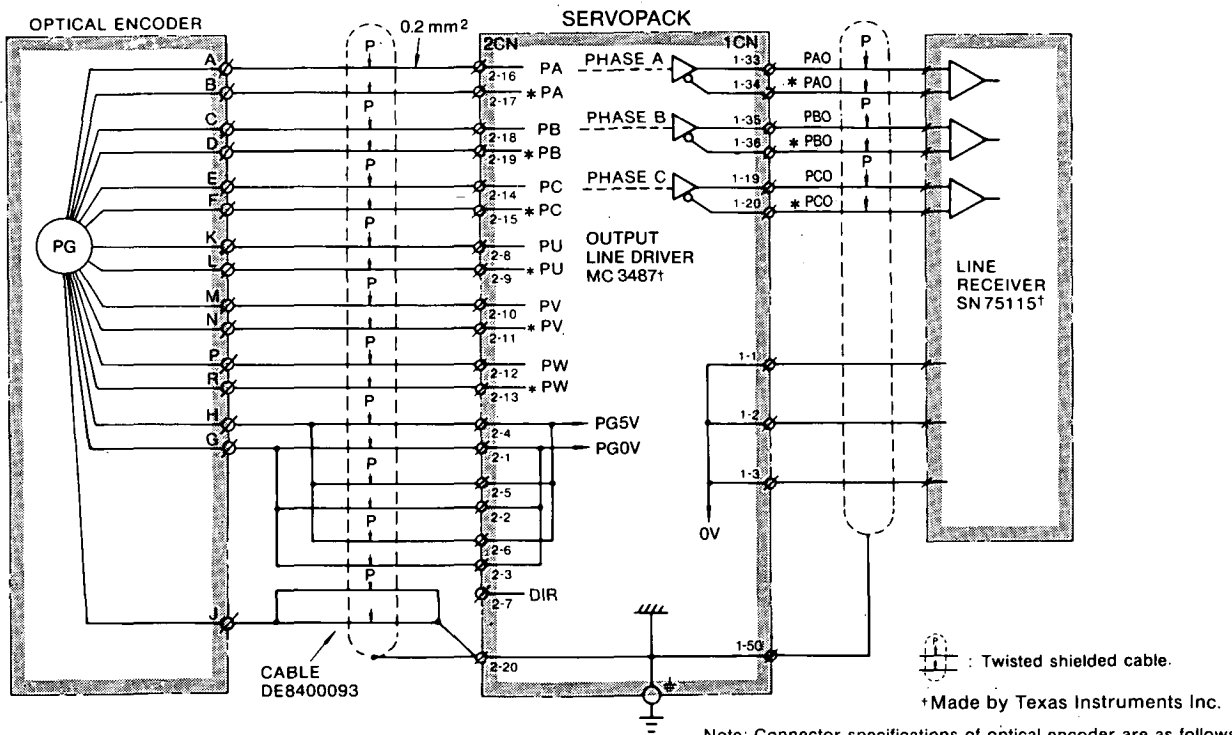

Note: Connector specifications of optical encoder are as follows.
 Connector — Type MS3102A20-29P (Receptacle)
 Accessory (not attached) — Type MS3108B20-29S (Angle plug)
 Type MS3057-12A (Cable clamp)

Fig. 5.5 Caulking Type Connector 2CN Connection and 1CN Output Processing (when using Connection Cable DE8400093)

6. OPERATION

6.1 POWER ON AND OFF

Arrange the sequence so that the power is simultaneously supplied to the main circuit (R.S.T) and the control circuit (r,t), or supplied to the control circuit first, then the main circuit (Figs. 6.1 and 6.2).

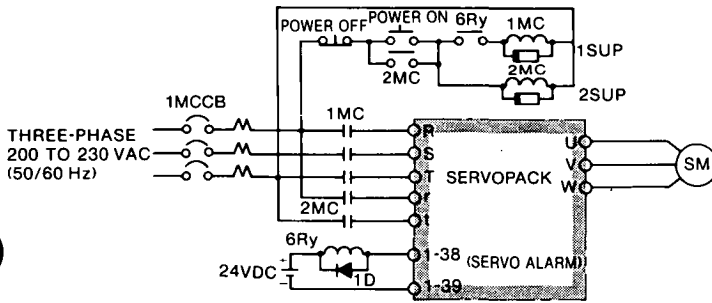
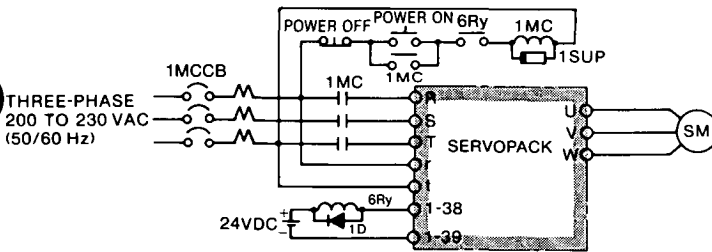

Fig. 6.1 Connection Example for Simultaneous Control Power ON/OFF



1SUP, 2SUP: Surge absorber CR50500BA or equivalent (made by Okaya Electric Industries Co., Ltd.)
1D: Flywheel diode (to prevent spike of 6Ry)

Fig. 6.2 Connection Example for Main-circuit Power ON/OFF

Arrange the sequence so that the power is simultaneously cut (including momentary power failure) (Fig. 6.1), or the power to the main circuit is cut first, then the control circuit (Fig. 6.2). The order is the reverse of the power ON sequence. Precautions for connections in Figs. 6.1 and 6.2 are as follows.

PRECAUTIONS FOR CONNECTIONS

- Make sequence to assure that the main-circuit power will be cut OFF by servo alarm signal.
- If the control circuit is turned OFF, the LED indicating the kind of servo alarm also goes OFF.
- When power is supplied to the power ON/OFF sequence shown in Fig. 6.1, the normal signal is set (6Ry is turned ON) in the control circuit after a maximum delay of 1 second.

When the power is turned ON, a servo alarm signal continues for approximately 1 second (normally 200 to 300ms) to initialize the SERVOPACK.

Hold the main-circuit power ON signal for approximately 1 second. However, this is unnecessary in the sequence in Fig.6.2, because the control power is always turned ON.

- Since SERVOPACK is of a capacitor input type, large recharging current flows when the main circuit power is turned ON (recharging time: 0.5s). If the power is turned ON and OFF frequently, the recharging-current limit resistor may be degraded and a malfunction may occur. Do not turn the power ON or OFF frequently.
- Before power ON or OFF, turn OFF the "Servo-ON" switch to avoid transient troubles.

6.2 CONFIGURATION OF I/O CIRCUIT

6.2.1 Input Circuit

(1) Servo ON [$\overline{S-ON}$]

This circuit is used to turn ON the main power drive circuit of the SERVOPACK. When the signal of the circuit is not input (Servo OFF), the motor cannot be driven. If this signal is applied during motor running, the motor will coast to a stop.

NOTE

Before turning power ON or OFF, turn OFF the "Servo-ON" switch to avoid troubles resulting from transient current.

(2) Proportional drive reference circuit [$\overline{P-CON}$]

This circuit switches the speed amplifier from PI drive to P drive.

Normally, motor repeats vibration by one-pulse response with Servo locked (motor stop) status. However, this vibration can be decreased by P drive reference ON.

For attaching load at Servo locked, this circuit cannot be used because Servo rigidity decreases under P drive.

6.2.1 Input Circuit (Cont'd)

(3) Forward and reverse running prohibit [P-OT, N-OT]

These circuits are used to stop the forward running of the motor (counterclockwise when viewed from the drive end of the motor) and reverse running. These circuits prohibit output current to drive the motor. Therefore, the motor will be free running at prohibit input open.

NOTE

When the overtravel prevention circuit is not used, connect 1CN- (26) and (27) and 1CN- (41) and (42).

(4) Alarm reset [ALRES]

This signal resets the alarm status. While this signal is turned ON, error counter also is cleared.

After checking alarm contents, turn ON the alarm reset signal by snapping action (10 μ s or more, ON) under Servo OFF status.

If this signal is turned ON at no alarm status, clear operation is executed for error counter.

Fig. 6.3 shows input circuit (1) to (4) above.

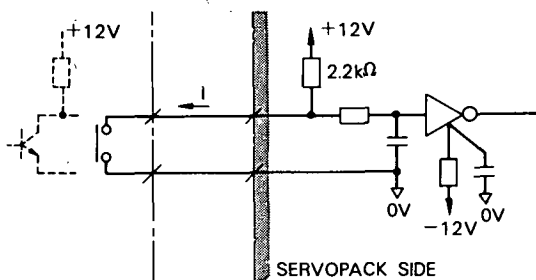

Fig. 6.3 Input Circuit (1)

Drive by relay contact or transistor (collector open or with +12V pull-up resistor). For relay contact, use high reliable contact relay for low level (12V, 5mA).

(5) Input Reference Pulse

There are two types of modes for reference pulse input:

- Main input (SIGN 1, PULS 1)
- Auxiliary input (SIGN 2, PULS 2)

(a) Main input [PULS 1 (*PULS 1), SIGN 1(*SIGN 1)]

(i) Reference pulse mode

The following input mode can be selected by setting of SW 20- (1), (2) and (3). Refer to Table 6.2.

- Sign + pulse train
- Two-phase pulse with 90° phase difference
- CW/CCW pulse train

(ii) Voltage level and timing of reference pulse

The voltage levels of available reference pulses are +12V and +5V levels. Set by switch SL20.

Table 6.1 Reference Pulse Voltage Level Setting

Voltage Level	SL 20 Setting		
+12 V	1	2	3
	o	<input type="checkbox"/>	<input type="checkbox"/>
+5 V	1	2	3
	<input type="checkbox"/>	<input type="checkbox"/>	o

For details, refer to Table 6.4.

(iii) Input circuit

Fig. 6.4 shows the configuration of input circuit. For output type of drive side, open collector, with pull-up resistor or line driver are available. For driving the line driver, connect the reversal output to *SIGN 1 and *PULS 1, respectively. Set the voltage level to +5V.

Table 6.2 Reference Pulse Mode

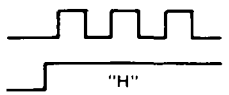
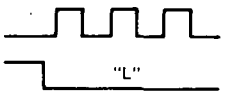
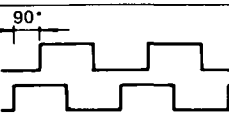
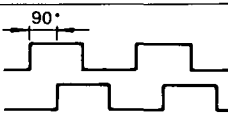
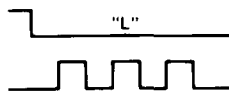
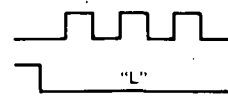
Reference Pulse Mode	Input Pin No.	Forward Running Reference of Motor	Reverse Running Reference of Motor	Input Multiplier †	SW20†		
					①	②	③
Sign + Pulses	1CN-⑳ 1CN-㉑			—	○	○	
90° Phase Difference 2-phase Pulses* (1, 2 or 4 Times)	1CN-⑳ 1CN-㉑			× 1	○	○	○
				× 2		○	○
				× 4	○		○
CW Pulses + CCW Pulses	1CN-⑳ 1CN-㉑			—		○	

* The multiplier can be set for 90° phase difference, 2-phase pulse input.

† Circles in SW20 show the positions for installing the setting plugs on the pins.

† Defines the method of counting the input pulse waves in Servopack. Table 6.3 shows the forward running reference for 90° phase difference 2-phase pulses when phase A = phase B = f(pps).

Table 6.3 Counting Method of Reference Pulse

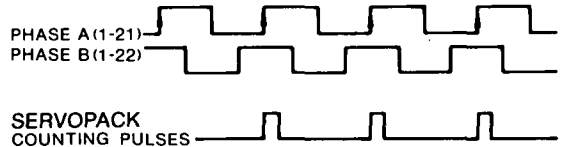
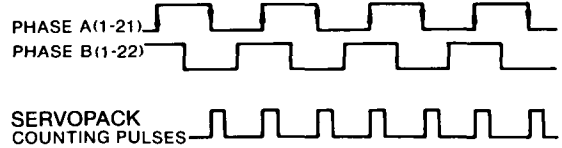
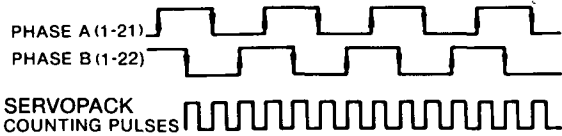
Multiplier	Content of Pulse Counting of SERVOPACK	Reference Pulse Frequency of SERVOPACK
× 1	Counts only the leading edge of phase-A pulse input (1CN-⑳). 	f (pps) [Nr/min*]
× 2	Counts the leading and trailing edges of phase A pulse input (1CN-⑳). 	$2 \times f$ (pps) [2×Nr/min]
× 4	Counts the leading and trailing edges of phase A pulse input (1CN-⑳) and phase B pulse input (1CN-㉑). 	$4 \times f$ (pps) [4×Nr/min]

* Motor speed

6. 2. 1 Input Circuit (Cont'd)

Table 6. 4 Applicable Voltage Level and Timing

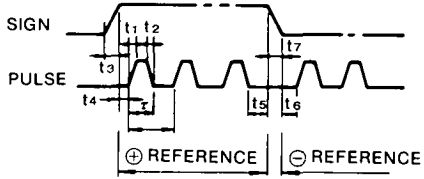
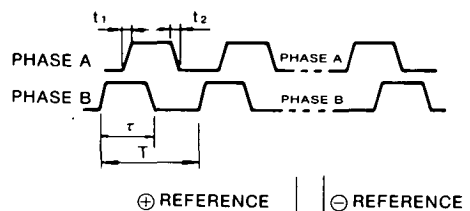
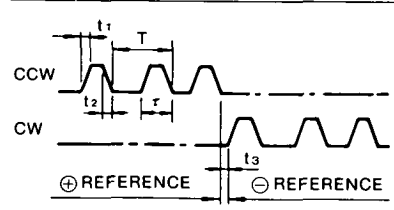
Item		Electrical Specifications		Remarks
Voltage Level of Signal	+ 12 V Level	H Level	+ 10.8 V to + 12 V	+ 5 V level or + 12 V level is set by internal switch SW20.
		L Level	0 V to + 1.2 V	
	+ 5 V Level	H Level	+ 4.2 V to + 5 V	
		L Level	0 V to + 0.8 V	
Reference Pulse Signal Mode	Sign + Pulse Input (SIGN + PULSE Signal) • Max Reference Frequency: 100 kpps	 <p> $t_1, t_2 \leq 0.1 \mu s$ $r \geq 5 \mu s$ $t_3, t_7 \leq 0.1 \mu s$ $\frac{r}{T} \times 100 \leq 50 \%$ $t_4, t_5, t_6 > 5 \mu s$ </p>		SIGN : H — ⊕ REFERENCE L — ⊖ REFERENCE
	90° Phase Difference 2-phase Pulse (Phase A + Phase B) • Max Reference Frequency: 100 kpps	 <p> $t_1, t_2 \leq 0.1 \mu s$ $\frac{r}{T} \times 100 = 50 \%$ </p> <p> ⊕ REFERENCE ⊖ REFERENCE PHASE B : 90° AHEAD OF PHASE A PHASE B : 90° BEHIND PHASE A </p>		Multiplier Mode is set by the internal switch SW20. • Max reference frequency: × 1: 100 kpps × 2: 50 kpps × 4: 25 kpps
	CCW Pulses + CW Pulses • Max Reference Frequency: 100 kpps	 <p> $t_1, t_2 \leq 0.1 \mu s$ $r \geq 5 \mu s$ $t_3 > 5 \mu s$ $\frac{r}{T} \times 100 \leq 50 \%$ </p>		—

Note: Maximum reference frequency is 200 kpps.

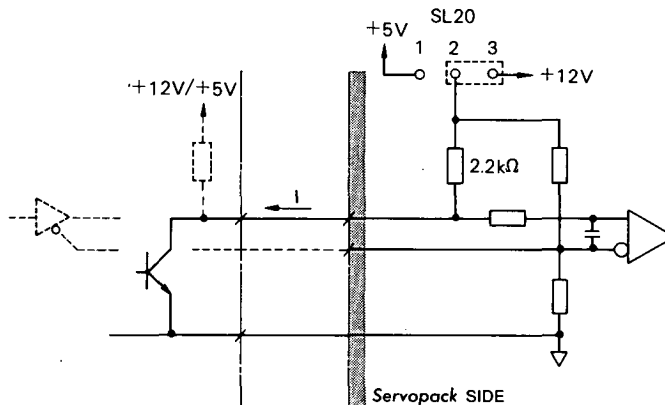

Fig. 6. 4 Input Circuit (2)

(iv) Other functions

The effective logic of reference pulse mode is H level in Table 6.2. The effective logic can be changed to L level by SW 40 - ③ and ④.

- Short pin OFF on SW 40 - ③ and ④ : Logic in Table 6.2 is effective.
- Short pin ON on SW 40 - ③ and ④ : Logic in Table 6.2 is reversed.

Where the effective logic of reference pulse is reversed individually, set the setting pins individually. The short pins correspond as follows:

- SW 40 - ③ → 1 CN - ⑳ input
- SW 40 - ④ → 1 CN - ㉑ input

(Example)

Reference pulse mode: Sign + pulses
 SW40 - ③ : setting pin OFF
 SW40 - ④ : setting pin ON

↓
 Motor is forward running when 1 CN - ㉑ input is L.

(b) Auxiliary input [PULS 2, SIGN 2]

(i) Reference pulse mode

The three modes can be selected by setting of SW20 - ④, ⑤ and ⑥, as shown in Table 6.5.

Table 6.5 Reference Pulse Mode Setting

Reference Pulse Mode	Input Multiplier	SW 20		
		④	⑤	⑥
Sign + Pulses	—	○	○	
90° Phase Difference 2-phase	× 1	○	○	○
	× 2		○	○
	× 4	○		○
CW/CCW Pulse Train	—		○	

(ii) Voltage level and timing of reference pulse

The voltage level is +12V(fixed). The timing is the same as Table 6.4.

(iii) Input circuit

The configuration of input circuit is the same as Fig. 6.3. However, input filter constant differs from it. Driving by line driver cannot be accomplished. Reverse function of effective logic is not available.

(6) Clear Signal (CL)

Normally, set the clear signal to 'H.' If 'L' is set, the contents of error counter become zero and positioning loop will be ineffective.

(a) Voltage level

Voltage level +12V/+5V can be switched at SL10.

Table 6.6 Voltage Level Setting

Voltage Level	SL10		
	1	2	3
+12V	○	○	○
+5V	○	○	○

(b) Logic reversion

Effective logic can be reversed when setting pin of SW40 - ② is turned OFF.

- Setting pin of SW40 - ②
 ON: Clear at L
 OFF: Clear at H

(c) Derivative action

During clear signal turning ON, differential action can be executed when setting pin of SW40 - ⑤ is turned ON. However, contents of error counter are always zero.

- Setting pin of SW40 - ⑤

ON: Differential action
 OFF: General action (always clear during clear signal turning ON)

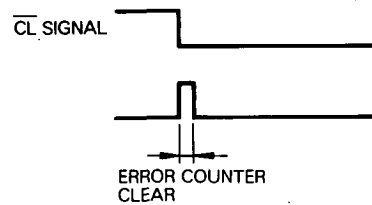

Fig. 6.5 Differential Action of Clear Signal

(d) Note for clear signal usage

- When the clear signal is turned on when applying the reference pulse, the contents of error counter become zero. However, when applying the feed forward compensation, speed command voltage by feedforward compensation is output.
- When the motor shaft is rotated at servo OFF, lag pulses are given to the error counter by feedback pulse. In this case, be sure to turn ON the Servo ON signal after turning on the clear signal.

6.2.1 Input Circuit (Cont'd)

- When the clear signal is used with the Servo ON signal, connect as shown in Fig. 6.6. For clear signal, set the voltage level to +12V, and reverse the logic and clear by H.

In this way, error counter is utilized by Servo ON or clear state at Servo OFF.

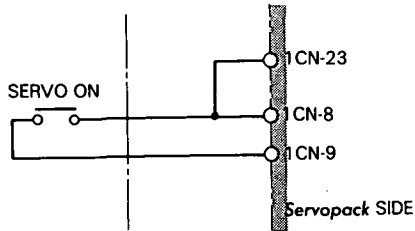

Fig. 6.6 Sequential Operation of Servo ON and Clear Signals

- The voltage level settings of \overline{CL} signal and \overline{INH} signal are in common. Therefore if \overline{CL} signal is set to +12V level, \overline{INH} signal is also at the +12V level and vice versa.

(7) Reference pulse input switching signal (\overline{INH})

Normally, set the reference pulse input to "L." Main reference pulse input is closed and auxiliary reference pulse input is effective by L setting of \overline{INH} signal.

(a) Voltage level

Refer to Table 6.6.

(b) Logic reversion

Effective logic can be reversed when setting pin of SW40 - ① is turned ON.

- Setting pin of SW40 - ①

ON: Input switching at H

OFF: Input switching at L

6.2.2 Output Circuit

There are seven output circuits for each sequence: position completion, overflow, servo alarm, servo ready, MCCB trip, overload detection, and motor run detection. These output circuits are non-contact output. Voltage and current specifications are as follows:

- Applied voltage (V_{max}) ≤ 30 VDC
- Operational current (I_p) ≤ 100 mA

The construction of output circuit is shown in Fig. 6.7. Output circuit needs a separate power supply. It is recommended to use +24V power.

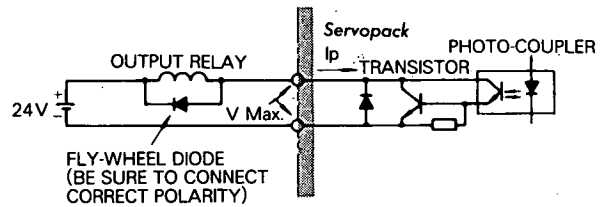

Fig. 6.7 Output Circuit

(1) Position completion signal (\overline{COIN})

position completion signal is turned ON when contents of error counter are within internal setting values. As internal setting values, ± 1 to ± 7 pulses or ± 63 pulses can be set. This signal is used to advance the sequence.

The position completion width is set at SW10 - ③, ④, ⑤ and ⑥. (See Table 6.7.) However, this setting must correspond to the number of error counter bits (bit numbers of D/A converter). (See Table 6.8.)

Table 6.7 Position Completion Width Setting

Position Completion Width Setting (Pulses)	SW10			
	③	④	⑤	⑥
± 1		○	○	
± 2	○		○	
± 3			○	
± 4	○	○		
± 5		○		
± 6	○			
± 7				
± 63				○

Table 6.8

Bit Numbers of D/A Converter	Position Completion Width (Pulses)
9	± 2
10	± 3
11	± 4
12	± 5

Bit numbers of D/A converter are set at SW10 - ① and ②. (See Table 6.9) These bit numbers are determined according to condition of applied motor or machine or applied condition of reference pulse. The smaller the setting bit numbers, the higher the position loop gain becomes.

Table 6.9 Setting of Bit Numbers of D/A Converter

Bit Numbers of D/A Converter	SW10	
	①	②
9	○	○
10		○
11	○	
12		

(2) Overflow detecting signal [OVER]

This signal is turned ON when lag pulses of error counter reach two times or more the setting bit number of D/A converter.

If overflow is detected, SERVOPACK becomes Servo OFF mode abruptly and coasts to a stop.

(3) Servo alarm [ALM]

This signal monitors alarm state of 13 types. If any trouble occurs, the power drive circuit in the SERVOPACK goes OFF. For details of alarm contents, see Par. 6.3(2).

(4) Servo ready [S-RDY]

After control power and main circuit power are turned ON, this signal is turned ON with no alarm.

(5) MCCB trip [MCB]

This signal is turned on when the SERVOPACK built-in circuit protector trips.

(6) Overload detection [OVER]

This signal is turned off when overload of SERVOPACK is detected. For details, see Par. 6.3.(3).

(7) Motor run detection [TGON]

When motor speed average for 5ms exceeds following speed, after 1 or 2 ms, this signal is turned on.

- M series motor: +20r/min ±10% or more
- F series motor: +25r/min ±10% or more
- S series motor: +40r/min ±10% or more

6.2.3 Optical Encoder (PG) Output Circuit [PAO, *PAO, PBO, *PBO, PCO, *PCO]

Phases A, B and C (original point) signals for the optical encoder, PG are output. The output signal specifications are as follows:

(1) Signal form

- Two-phase pulse with 90° pulse difference (Phases A and B)
- Original point pulse (Phase C)

(2) Output circuit and receiver circuit

Output circuit is line driver output. For connection, see Fig. 6.8.

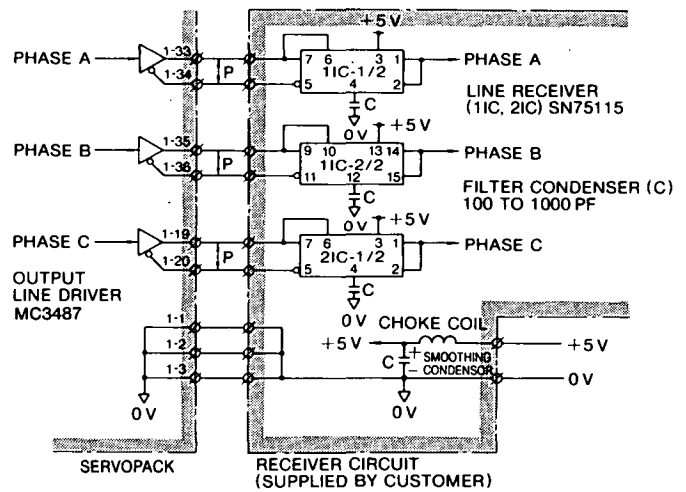

□: Twisted cable

Fig. 6.8 Output Circuit and Receiver Circuit

(3) Output phase

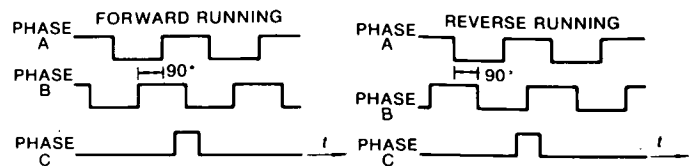

Note: Phase C (original point pulse) is synchronized with phase A.

Fig. 6.9 Output Phase

6.2.3 Optical Encoder (PG) Output Circuit
 [PAO, *PAO, PBO, *PBO, PCO, *PCO] (Cont'd)

(4) Pulse resolution

The pulse frequency of the PG can be further divided into 1/N (N=1 to 60) or 2/N (N=2 to 64) by using the divider in the SERVOPACK. The phase relation is the same as in (3), above. Set the pulse frequency dividing ratio according to Table 6.10.

The dividing ratio must be able to divide the pulses of the optical encoder. For example, in an optical encoder of 5000 pulses/rev, 1/3, 1/6, or 1/7 cannot be used. The dividing output is input to positioning control circuit as a positioning feedback pulse. For details, see Par. 6.4. Fig. 6.10 shows the optical encoder output waveform under the dividing pulse frequency. The C-phase (original point) pulse has the same pulse width of dividing ratio 1/1 as PG dividing.

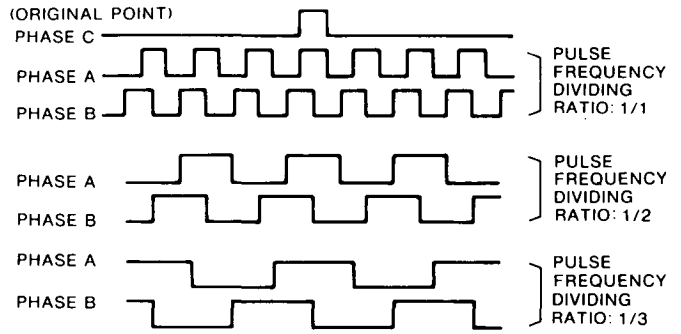

Fig. 6.10 Output Waveform of Optical Encoder

Table 6.10 Setting of PG Pulse Frequency Dividing Ratio

SW2								Pulse Frequency Dividing Output (pulses/rev)						
1	2	3	4	5	6	7	8	PG Pulse Frequency Dividing Ratio (1/N)	PG=6000	PG=5000	PG=4000	PG=2500	PG=1500	PG=1000
○	○	○	○	○	○	○	○	1/1	6000	5000	4000	2500	1500	1000
	○	○	○	○	○	○	○	1/2	3000	2500	2000	1250	750	500
○		○	○	○	○	○	○	1/3	2000	—	—	—	500	—
		○	○	○	○	○	○	1/4	1500	1250	1000	625	375	250
○	○		○	○	○	○	○	1/5	1200	1000	800	500	300	200
	○		○	○	○	○	○	1/6	1000	—	—	—	250	—
		○	○	○	○	○	○	1/8	750	625	500	—	—	125
	○	○		○	○	○	○	1/10	600	500	400	250	150	100
		○		○	○	○	○	1/12	500	—	—	—	125	—
○				○	○	○	○	1/15	400	—	—	—	100	—
				○	○	○	○	1/16	375	—	250	—	—	—
		○	○		○	○	○	1/20	300	250	200	125	75	50
			○		○	○	○	1/24	250	—	—	—	—	—
○	○	○			○	○	○	1/25	240	200	160	100	60	40
	○				○	○	○	1/30	200	—	—	—	50	—
			○	○		○	○	1/40	150	125	100	—	—	25
				○		○	○	1/48	125	—	—	—	—	—
	○	○	○			○	○	1/50	120	100	80	50	30	20
		○				○	○	1/60	100	—	—	—	25	—
	○	○	○	○	○			2/2	6000	5000	4000	2500	1500	1000
○		○	○	○	○			2/3	4000	—	—	—	1000	—
		○	○	○	○			2/4	3000	2500	2000	1250	750	500
○	○		○	○	○			2/5	2400	2000	1600	1000	600	400
	○		○	○	○			2/6	2000	—	—	—	500	—
			○	○	○			2/8	1500	1250	1000	625	—	250
	○	○		○	○			2/10	1200	1000	800	500	300	200
		○		○	○			2/12	1000	—	—	—	250	—
○				○	○			2/15	800	—	—	—	200	—
				○	○			2/16	750	—	500	—	—	125
		○	○		○			2/20	600	500	400	250	150	100
			○		○			2/24	500	—	—	—	125	—
○	○	○			○			2/25	480	400	320	200	120	80
	○				○			2/30	400	—	—	—	100	—
			○	○				2/40	300	250	200	125	75	50
				○				2/48	250	—	—	—	—	—
	○	○	○					2/50	240	200	160	100	60	40
		○						2/60	200	—	—	—	50	—

6.2.4 Torque Reference Monitor and Speed Monitor (TRO-M, VTG-M)

Motor output is used for monitoring torque and speed at motor running. When an instrument is connected to measure torque and speed, make the connection as shown in Fig. 6.11, using a DC ammeter of full scale $\pm 1\text{mA}$ (both swing).

- Torque monitor output (1CN-15): $\pm 3.0\text{V} \pm 10\%$ /rated torque
- Speed monitor output (1CN-16):
M, F series — $\pm 4.0\text{V} \pm 5\%$ /1000r/min
S series — $\pm 2.0\text{V} \pm 5\%$ /1000r/min
- Instrument: Full scale $\pm 1\text{mA}$ (both swing) ammeter. Use ammeter of DCF -6 or DCF -12F or equivalent made by Toyo Instrument Co., Ltd.

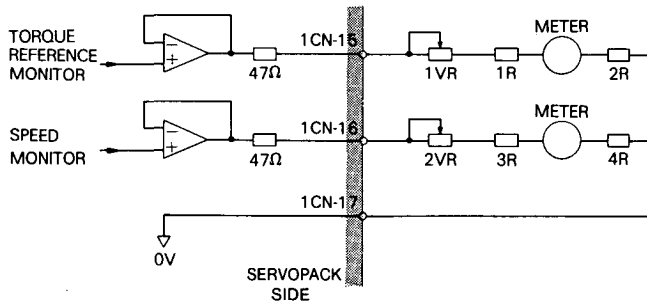

- Notes:
1. Torque reference monitor increases output error in range of motor rated speed or more.
 2. 1R to 4R, 1VR, 2VR are selected by full-scale setting. (Select 1R=2R, 3R=4R. 1VR and 2VR is for fine adjustment.)

Fig. 6.11 Connection with Monitor Output

6.3 PROTECTIVE CIRCUIT

SERVOPACK provides functions to protect the body and motor from malfunctions.

(1) Dynamic brake function

SERVOPACK incorporates a dynamic brake for emergency stop. This brake operates when:

- Alarm (fault detection) occurs, or
- Servo ON command is opened, or
- Main power supply is tuned off.

Normally, this dynamic brake is not applied while the motor stops, but can be made operational by switching built-in switch (SW 4-5) from OFF to ON.

(2) Trouble detecting functions

Table 6.11 Trouble Detecting Functions

Trouble	Detection
Overcurrent	Overcurrent flow in the main circuit (at 1.2 times min. inst max current.)
Circuit Protector Trip	Circuit protector tripped
Regeneration Trouble	Regenerative circuit not activated in SERVOPACK.
Overvoltage	Excessively high DC voltage in the main circuit (approx 420V.)
Overspeed	Excessively large speed reference input.
Voltage Drop	Low DC voltage in the main circuit after power ON. (150V or less.)
Overload	Overload condition of motor and SERVOPACK.
Heat Sink Overheat	Overheat of heat sink (approx 85°C min.)
A/D Error	Element error on the printed circuit board of SERVOPACK.
Open Phase	Any one phase open in three-phase power supply.
Overrun Prevention	Wrong wiring of motor circuit or PG signal line.
CPU Error	Any error of CPU
Over Flow	Lag pulses of error counter reach two times or more the setting bit number of D/A converter.

6.3 PROTECTIVE CIRCUIT(Cont'd)

(3) Overload (OL) detection level

Fig. 6.12 shows the setting of overload detection level at 100% rated motor current.

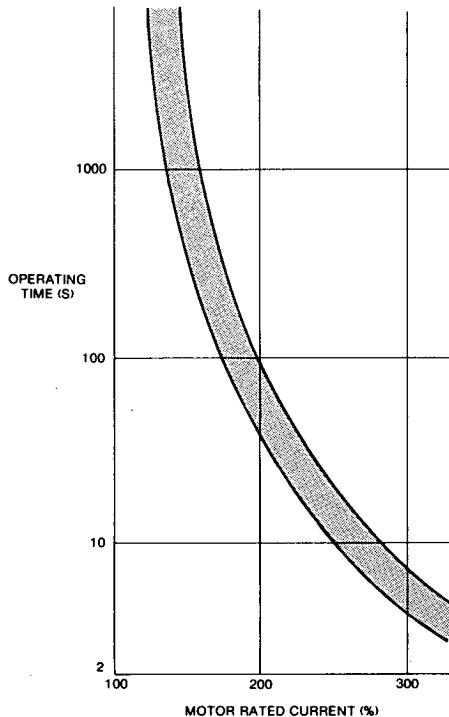

Fig. 6.12 Overload Characteristics

(4) Servo alarm output [ALM+, ALM-]

If any trouble detection circuits in Table 6.11 activate, the power drive circuit in the SERVOPACK goes off, 7-segment LEDs indicate the operation condition and a servo alarm signal is output.

NOTE

- Regeneration trouble and overflow among LED trouble indications are displayed in common. But these troubles are distinguished by other LED indications. (See Par. 6.6.)
- If overflow is detected, SERVOPACK abruptly becomes Servo OFF mode and the motor coasts to a stop. Batched servo alarm output and LED trouble indications are executed after waiting approximately 0.5 second after alarm occurs. If main circuit power is cut off within 0.5 second after overflow occurs, servo alarm outputs and LED trouble indications are ineffective.

(5) Protective circuit operation

An alarm signal indicates some trouble. Check the cause and correct the trouble, and restart the operation. Before checking the cause, turn OFF the power to the main circuit to avoid danger. Apply the sequence so that the alarm signal turns OFF only the main circuit (R, S, T), as shown in Figs. 6.1 and 6.2. This allows rapid reaction in the event of a malfunction.

If the power to the control circuit (U, V) is simultaneously turned OFF, this also turns OFF the LED in the SERVOPACK indicating the cause of the alarm signal.

CAUTION

When an alarm signal cuts off only the main circuit, set the speed reference to OFF before supplying power to the main circuit to resume the operation.

(6) Resetting servo alarm

To reset the servo alarm, depress the **RESET** (blue pushbutton switch) alarm release [ALRES] signal of input signals on the printed circuit board in the SERVOPACK. See Par. 6.2.1.(4).

If **7.** or **A** is on (e.g., SERVOPACK is overloaded or the heat sink is overheated), the reset alarm is not immediate and occurs a few minutes later.

(7) LED trouble indications

Table 6.4 LED Trouble Indications (7-segment, Red)

Indication	Detection	Output Signals
<input type="checkbox"/>	Base current not interrupted (normal operation).	—
<input type="checkbox"/>	Base current is interrupted in Servopack power circuit.	—
1.	Overcurrent	When a protection circuit in SERVOPACK functions, power drive circuit is base-blocked. This block-status is released by "RESET" operation.
2.	Circuit protector tripped	
3.	Regeneration trouble, overflow	
4.	Overvoltage	
5.	Overspeed	
6.	Voltage drop	
7.	Overload	
A.	Heat sink overheat	
b.	A/D error	
F.	Open phase	
C.	Overrun prevention	Servo alarm output
<input type="checkbox"/>	CPU error	

6.4 CONFIGURATION OF POSITIONING CONTROL LOOP

Fig. 6.13 shows basic block diagram of positioning control loop. The reference pulse frequency is 100 kpps (max). Therefore, feedback pulse frequency of error counter input should be 100 kpps or below.

Where encoder resolution is P (pulse/rev) and revolution range is N (r/min), set the frequency dividing (1) and multiplier mode so that the following formula is formed.

$$f_{PG(2)} = \frac{N \cdot P}{D_1} \times \frac{N}{60} \leq 100 \text{ kHz}$$

Note:

1/D : Ratio of frequency dividing (1)

M : Multiplier after frequency dividing (1)

$$f_{PG(1)}: \begin{cases} M=1 \dots f_{PG(1)} \leq 100 \text{ kHz} \\ M=2 \dots f_{PG(1)} \leq 50 \text{ kHz} \\ M=4 \dots f_{PG(1)} \leq 25 \text{ kHz} \end{cases}$$

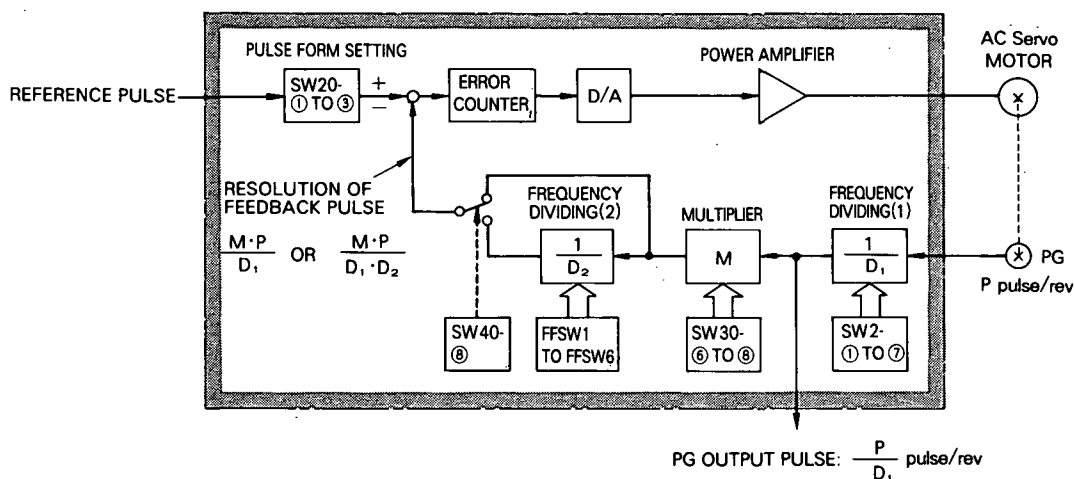

Fig. 6.13 Basic Block Diagram of Positioning Control Loop

6.4.1 Frequency Dividing (1) Setting (1/D₁)

Frequency dividing (1) is set at SW2-① to ⑦, referring to Table 6.10.

6.4.2 Multiplier Setting (M)

Multiplier mode can be set at 1, 2 or 4 multiplier. (See Table 6.13.) According to multiplier modes, output frequency of frequency dividing (1) should be the following values or below.

Multiplier mode Output frequency of frequency dividing (1) [fPG(1)]

× 1	100 kHz max.
× 2	50 kHz max.
× 4	25 kHz max.

Table 6.13 Multiplier Mode Setting

Multiplier Mode	SW 30		
	⑥	⑦	⑧
×1	○	○	○
×2		○	○
×4	○		○

6.4.3 Frequency Dividing (2) Setting (1/D₂)

- Where the frequency dividing ratio = 1:
If the frequency dividing (2) function is not used, turn off SW40 - ⑧ (no installation of setting plug).
- Where the frequency dividing setting is to be made:

Frequency dividing ratio k ($0 < k < 1$) is obtained by the formula below, when the following data are given from the specifications:

- Load displacement per motor revolution = ΔL mm
- Displacement per pulse (lowest setting unit) = $\Delta \ell$ mm/pulse
- Number of output pulses of PG per motor revolution = n pulses

$$0 < k = \frac{\Delta L / \Delta \ell}{n \times k} < 1$$

k : Multiplier (1, 2, 4)

6. 4. 3 Frequency Dividing (2) Setting (1/D₂) (Cont'd)

NOTE

The positioning accuracy is influenced by the value of the frequency dividing ratio k. Calculate it to at least 8 digits after the decimal point.

- (a) Turn ON switch SW40 - ⑧ (install the setting plug).
- (b) Calculate setting data of frequency dividing ratio.

The frequency dividing ratio data is set by rotary switches FFSW 1 to 6.

$$k = \frac{1}{D_2} = \frac{\sum_{n=1}^6 (FFSW.n)}{2^{23}}$$

Convert the value of [8388608 × k] into binary form.

$$\begin{aligned}
 [8388608 \times k] &= 1 \times (\text{FFSW-1 Data}) + 16 \\
 &\quad \times (\text{FFSW-2 Data}) + 16^2 (256) \\
 &\quad \times (\text{FFSW-3 Data}) + 16^3 (4896) \\
 &\quad \times (\text{FFSW-4 Data}) + 16^4 (65536) \\
 &\quad \times (\text{FFSW-5 Data}) + 16^5 (1048576) \\
 &\quad \times (\text{FFSW-6 Data})
 \end{aligned}$$

- (c) Set each scale of FFSW-1 to 6 according to each datum (0 to 15) shown in Table 6.14.

Table 6.14 Frequency Dividing Setting List

Data of FFSW-1 to 6	Scale of FFSW
0	0
1	1
2	2
3	3
4	4
5	5
6	6
7	7
8	8
9	9
10	A
11	B
12	C
13	D
14	E
15	F

- (3) Setting example:

Where frequency dividing ratio
k = 0.95768726,

- (a) $\sum_{n=1}^6 (FFSW.n)$
= 8388608 × 0.95768726 = 8033663.011
- (b) Round out decimals larger than 0.5 or otherwise disregard them and convert the result into hexadecimal form.
- (c) 8033663 = (7A957F) HEX

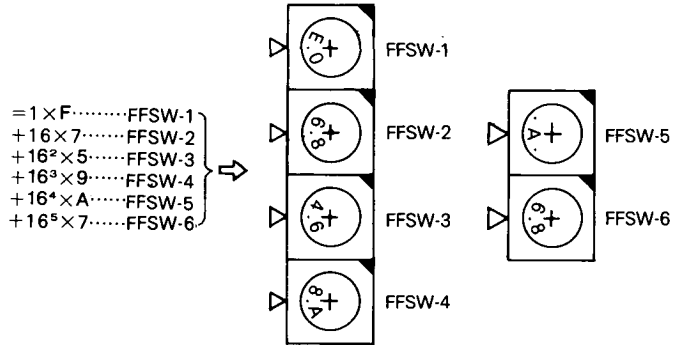

Note: Operation of frequency dividing (2) is 100 kHz maximum. Where the frequency dividing (2) function is used, set D₁ as the formula below.

$$\frac{P}{D_1} \times \frac{N}{60} < 50 \text{ kHz}$$

The multiplied data M (1.2 or 4) should be meet the formula below.

$$\frac{M.P}{D_1} \times \frac{N}{60} \leq 100 \text{ kHz}$$

6.5 RESOLUTION OF POSITIONING FEEDBACK PULSE

Table 6.15 shows resolution of positioning encoder for AC SERVOMOTOR and combined encoder at maximum speed. The standard encoder is set to maximum speed.

If operating resolution is reduced, resolution of positioning encoder can be increased according to the set frequency dividing (See Par. 6.4.)

Table 6.15 Resolution of Positioning Encoder (Standard)

AC SERVOMOTOR			Combined Encoder pulse/rev	Encoder Output Frequency kHz		Frequency Dividing		Multiplier Mode	Resolution of Positioning Encoder pulse/rev
Series	Rated Speed r/min	Max Speed r/min		At Rated Speed	At Max Speed	(1)	(2)		
M	1000	2000	6000	100	200	1/6	—	2	2000
			5000	83.3	166.7	1/5	—	2	
			4000	66.7	133.3	1/4	—	2	
F	1500	2500	6000	150	250	1/6	—	2	2000
			5000	125	208.3	1/5	—	2	
			4000	100	166.7	1/4	—	2	
S	3000	4000	2500	125	166.7	1/5	—	2	1000
			1500	75	100	1/3	—	2	
			1000	50	66.7	1/2	—	2	

6.6 DISPLAY

There are the following LED indications other than the 7-segment LED indications on the panel.

[P]: Control power (+5V) in SERVOPACK is normal.

[MP]: Main circuit voltage (200VDC or more) in Servopack is normal.

[A] **[B]** **[C]**: PG-phase A, phase B [frequency dividing (2) output] and phase C (origin pulse)

[DA1] **[DA2]**: Setting bit numbers of D/A converter (See Table 6.16.)

[2] **[4]** **[8]** to **[512]**: Lag pulse of error counter (See Table 6.17.)

[CLMP] *: D/A converter output is clamped (saturation).

[OVER] *: Overflow of error counter

[COIN]: Positioning completion

*The relation of **[CLMP]** and **[OVER]**

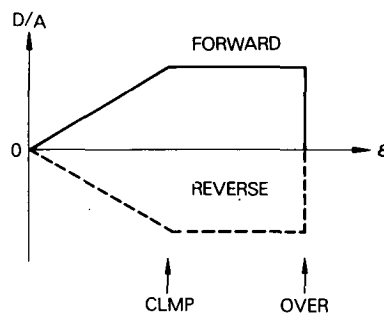

Fig. 6.14

- **[CLMP]** lights when lag pulses reach setting bit numbers of D/A converter.
- **[OVER]** lights when lag pulses reach two times the setting bit numbers of D/A converter. At this time, an alarm occurs and the motor will coast to a stop at Servo OFF mode. The error counter will be cleared.

6.6 DISPLAY(Cont'd)

Table 6.16 Setting Bit Numbers of D/A Converter

Setting Bit Numbers	LED Display	
	DA1	DA2
9		
10	●	
11		●
12	●	●

Note: The mark ● shows that LED lights.

Table 6.17 Lag Pulse Numbers of Error Counter

Setting Bit Numbers of D/A Converter	Lag Pulse Numbers
9	$D(\epsilon)/2$
10	$D(\epsilon)$
11	$2 \times D(\epsilon)$
12	$4 \times D(\epsilon)$

Note: Calculate the lag pulse number using table 6.17. Because the relationship of lag pulse numbers(ϵ) and total values D at error display LED lighting differ according to setting bit numbers of D/A converter.

6.7 SETTING OF INTERNAL SWITCHES

6.7.1 Switch Functions

The switches below are on the control circuit board.

3P switch: SL1, SL2, SL10 to SL40
(See Table 6.18.)

Setting pin: SW1 to SW4, SW10 to SW40
(See Table 6.19.)

Rotary switch: FFSW1 to FFSW6
(See par. 6.4.3.)

Table 6.18 3P Switch Functions List

3P Switch	Function	User Setting
SL1	Variable range of positioning loop gain adjustable volume.	Not possible
SL2	—	Not possible
SL10	Voltage level switching of INH and CL inputs.	+5V/+12V switching possible: 5V $\begin{matrix} 1 & 2 & 3 \\ \circ & \circ & \circ \end{matrix}$ 12V
SL20	Voltage level switching of PULS 1 and SIGN 1 inputs.	
SL30	Feedforward circuit filter time constant	Not possible
SL40	—	Not possible

Table 6.19 Setting Pin Functions List

Setting Pin.	Function	User Setting	Setting Pin	Function	User Setting		
SW1	1	Selection of AC SERVOMOTOR Type	SW10	1	Bit numbers setting of D/A converter	See Table 6.9.	
	2						
	3						
	4						
	5	Selection of combined encoder (PG)		See Table 6.21	5	Setting and positioning completion lag pulse width	See Table 6.7.
	6						
	7						
	8						
SW2	1	Setting of PG frequency dividing ratio [Frequency dividing (1)]	SW20	1	Input form setting of reference pulse (main input)	See Table 6.2	
	2						
	3						
	4						
	5			Input form setting of reference pulse (auxiliary input)	See Table 6.5.		
	6						
	7						
	8	Spare		—	8	—	Not possible
SW3	1	PI constant setting of speed amplifier	SW30	1	—	Not possible	
	2						
	3						
	4						
	5						
	6						
	7	f/V filter of speed feedback		ON: 1.2ms OFF: 0.1ms	7	Setting of multiplier mode	See Table 6.13.
	8	Mode switch		ON: Without OFF: With	8		
SW4	1	Setting of motor characteristics and SERVOPACK function	SW40	1	Setting effective logic	INH input signal	ON: H level effective OFF: L level effective
	2			\overline{CL} input signal		ON: L level effective OFF: H level effective	
	3			PULS 1 input signal		ON: L active OFF: H active	
	4			SING 1 input signal		ON: L active OFF: H active	
	5			Do not adjust.	5	Clear form setting of error counter	ON: Differential action OFF: General active
	6				6	BIAS compensation function	ON: Possible OFF: Not possible
	7				7	—	Not possible
	8	Spare		—	8	Frequency dividing (2) function	ON: Possible OFF: Not possible

Note: SW100 is spare for setting pin storage.

6.7.1 Switch Functions (Cont'd)

Table 6.20 Selection of AC SERVOMOTOR Type

Type	SW 1			
	①	②	③	④
M Series	<input type="radio"/>			<input type="radio"/>
F Series				<input type="radio"/>
S Series	<input type="radio"/>	<input type="radio"/>		<input type="radio"/>

Note: This setting may differ from other standard motors.

Table 6.21 Selection of Encoder (PG)

Encoder Resolution pulses/rev	SW 1			
	⑤	⑥	⑦	⑧
6000	<input type="radio"/>	<input type="radio"/>	<input type="radio"/>	
5000				<input type="radio"/>
4000	<input type="radio"/>			<input type="radio"/>
2500	<input type="radio"/>	<input type="radio"/>		<input type="radio"/>
1500	<input type="radio"/>		<input type="radio"/>	<input type="radio"/>
1000	<input type="radio"/>	<input type="radio"/>	<input type="radio"/>	<input type="radio"/>

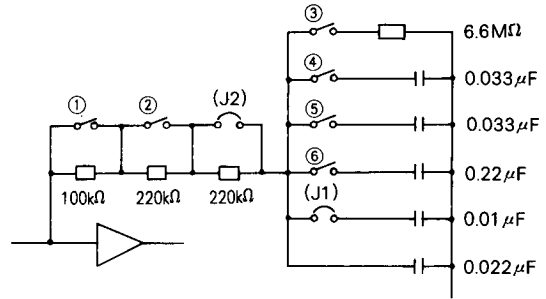

Fig. 6.15 Speed Amplifier PI Constant (SW3-① to ⑥)

6.7.2 Internal Switch Arrangements

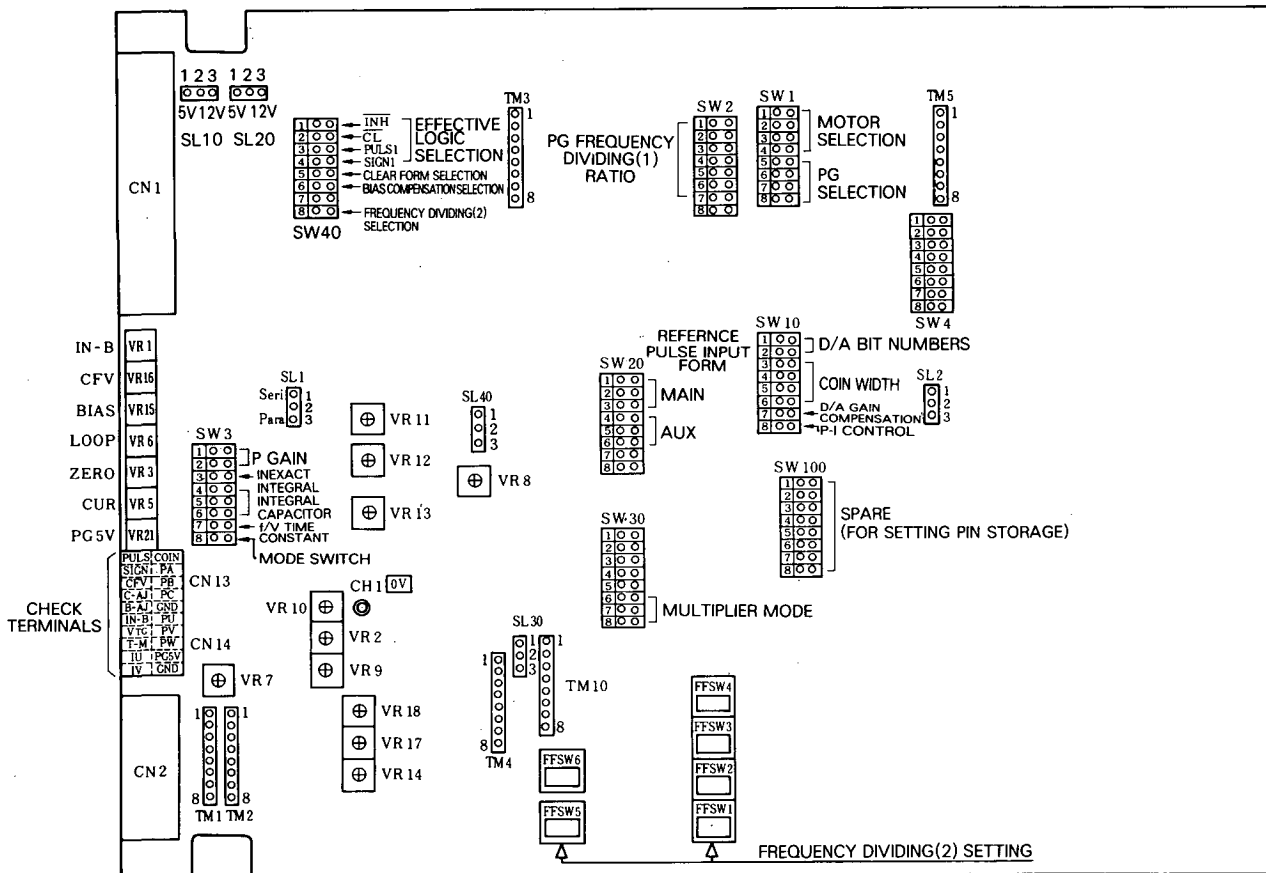

Fig. 6.16 Internal Switch Arrangements SERVOPACK Type CACR-PR BC3

6.7.3 Switch Setting Procedure

If setting alteration is required, reset using procedures below.

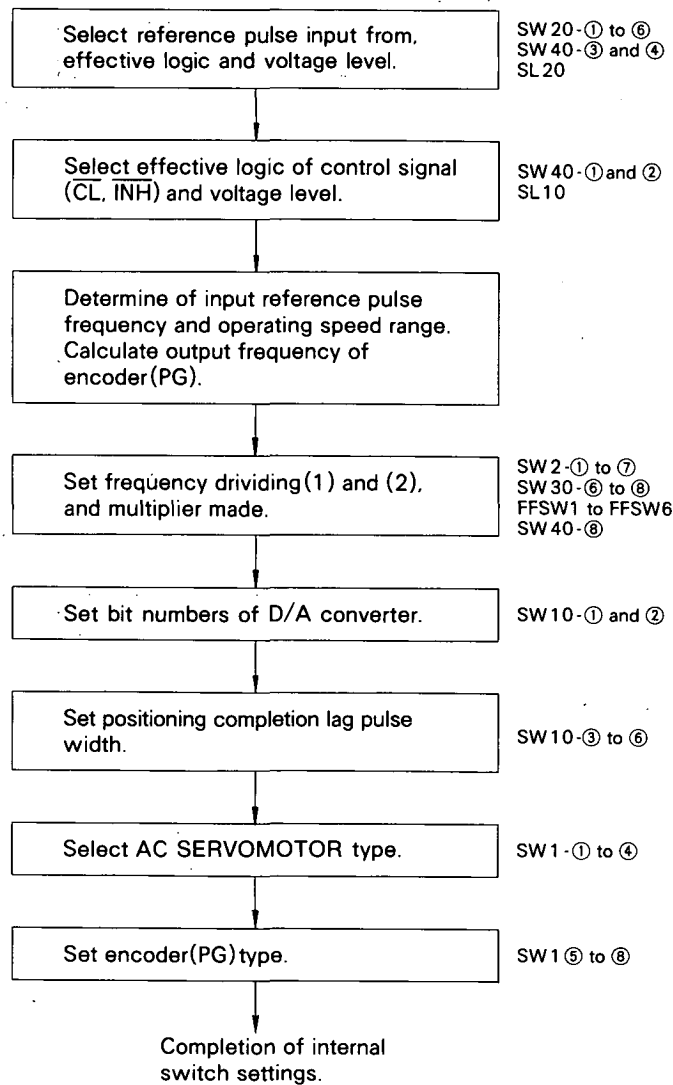

Fig. 6.17 Procedure for Switch Settings

6.8 ADJUSTMENT

There are seven potentiometers on the SERVOPACK panel: IN-B, CFV, BIAS, LOOP, ZERO, CUR and PG5V. Normally, where adjustment is required depending on the use, readjust the IN-B and LOOP. The adjustment of CFV and BIAS is used to compensate for high speed positioning. Table 6.22 shows potentiometer adjustment.

6.8 ADJUSTMENT (Cont'd)

Table 6.22 Potentiometer Adjustment

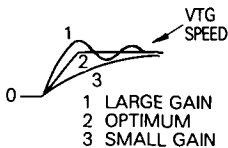
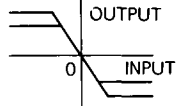
Potentiometer	VR1 (IN-B)	VR3 (ZERO)	VR5 (CUR)
Functions	Position Loop Gain Adjustment	Speed Amplifier Zero Adjustment	Starting Current Adjustment
How to Adjust	To increase gain, turn VR1 CW.	Compensate the following condition with zero adjustment. <ul style="list-style-type: none"> • Where the positioning completion signal is output unbalanced. • Where the vibration of one pulse response is large at servo lock. 	Turning VR5 CCW decreases the peak value of starting current. VR5 has been preset fully CW at the factory.
Characteristics	 <p>1 LARGE GAIN 2 OPTIMUM 3 SMALL GAIN</p>	—	 <p>Maximum output voltage of speed amplifier varies.</p>

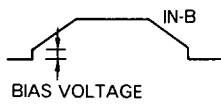
Potentiometer	VR6 (LOOP)	VR15 (BIAS)	VR16 (CFV)	VR21 (PG5V)
Functions	Speed Loop Gain Adjustment	Speed Reference Bias Compensation	Speed Reference Feed Forward Compensation	Voltage Adjustment of PG + 5V Power
How to Adjust	To increase gain, turn VR6 CW.	To increase bias compensation voltage, turn VR15 CW. If compensation is excessive, the motor will hunt.	Adds feed forward compensation to increase the apparent Kp value and to improve the response. Turning VR16 CW increases the compensation.	Voltage adjustment for PG power. VR21 has been preset at 5.25V at the factory.
Characteristics	To prevent hunting, turn VR6 CCW.		If compensation is excessive, the motor will hunt.	Turning VR21 CW increases the voltage. If the influence of voltage drop occurs due to long wiring PG, increase the voltage. Do not set VR21 to 6V or above.

6.9 CHECK TERMINAL

The check terminal arrangement on the panel is shown in Fig. 6.18. The check terminal functions are shown in Table 6.23.

Do not saturate the check terminal with irrelevant or extraneous substance.

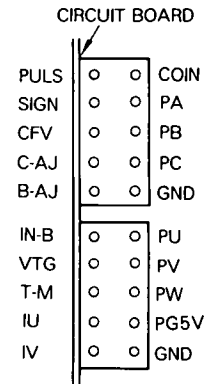

Fig. 6.18 Check Terminal Arrangement

Table 6.23 Check Terminal Functions

Symbol	Functions	
PULS	Reference pulse	PULS1 (or CW pulse train, two-phase pulse)
SIGN	(main input) signal	SIGN1 (or CCW pulse train, two-phase pulse)
CFV	Reference pulse f/V converter output.	
C-AJ	Speed reference feed forward compensation voltage.	
B-AJ	Speed reference BIAS compensation voltage.	
IN-B	Speed reference(D/A converter output voltage): approx. $\pm 6V$ /full bit.	
VTG	Speed feedback signal: <ul style="list-style-type: none"> • M, F series • S series $\pm 4V/1000\text{ r/min}$ $\pm 2V/1000\text{ r/min}$	
T-M	Torque reference monitor signal: $\pm 3.0V/100\%$	
IU	Motor current (Phase-U)	Type 03 05 07 10 15 20 30 44
IV	Motor current (Phase-V)	[V/A] 0.4 0.24 0.20 0.16 0.08 0.04
COIN	Positioning completion signal; COIN at L.	
PA	Optical encoder(PG) input signal.	Phase-A pulse input.
PB		Phase-B pulse input.
PC		Phase-C pulse input.
PU	Pole sensor input signal.	Phase-U pulse input.
PV		Phase-V pulse input.
PW		Phase-W pulse input.
PG5V	Optical encoder(PG) power supply voltage: +5V.	
GND	Signal 0V.	

Notes:

- Optical encoder(PG) input signal
 - Waveform at motor forward running.

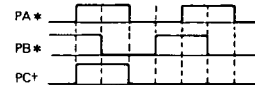

* Two-phase pulse with 90° phase difference.

† One generation per motor turning. Synchronizing with PA.

- Pole sensor input signal.
 - Waveform at motor forward running.

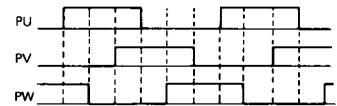

- The motor generating torque conversion by torque reference monitor signal is large at high-speed range. Compute the precise data by motor current measurement.

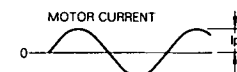

$$\text{MOTOR GENERATING TORQUE} = \frac{I_p}{\sqrt{2}} \times \text{TORQUE CONSTANT}$$

6. 10 PRECAUTIONS FOR APPLICATION

6. 10. 1 Minus Load

The motor is rotated by the load; it is impossible to apply brake (regenerative brake) against this rotation and achieve continuous running.

Example: Driving a motor to lower objects (with no counterweight)

Since SERVOPACK has short time regenerative brake capability (corresponding to the motor stopping time), for application to a minus load, contact your YASKAWA representative.

6. 10. 2 Load Inertia (J_L)

The allowable load inertia J_L converted to the motor shaft must be within five times the inertia of the applicable AC SERVOMOTOR. If the allowable inertia is exceeded, an overvoltage alarm may be given during deceleration. If this occurs, take the following actions:

- Slow down the deceleration curve.
- Decrease the maximum speed.

For details, contact your YASKAWA representative.

6. 10. 3 High Voltage Line

If the supply voltage is 400/440 V, the voltage must be dropped three-phase, 400/440V to 200 V by using a power transformer. Table 6.26 shows the transformer selection. Connection should be

made so that the power is supplied and cut through the primary or secondary side of the transformer. Single-phase 100V class power supply should not be used.

6. 11 PRECAUTIONS OF OPERATION

6. 11. 1 Noise Control

SERVOPACK uses a power transistor in the main circuit. When these transistors are switched, the effect of $\frac{di}{dt}$ or $\frac{dv}{dt}$ (switching noise) may sometimes occur depending on the wiring or grounding method.

The SERVOPACK incorporates CPU. This requires wiring and provision to prevent noise interference. To reduce switching noise as much as possible, the recommended method of wiring and grounding is shown in Fig. 6.19.

(1) Grounding method (Fig. 6.19)

- Motor frame grounding

When the motor is at the machine side and grounded through the frame, $C_f \frac{dv}{dt}$ current flows from the PWM power through the floating capacity of the motor. To prevent this effect of current, motor ground terminal Ⓣ (motor frame) should be connected to terminal Ⓧ of SERVOPACK. (Terminal Ⓧ of SERVOPACK should be directly grounded.)

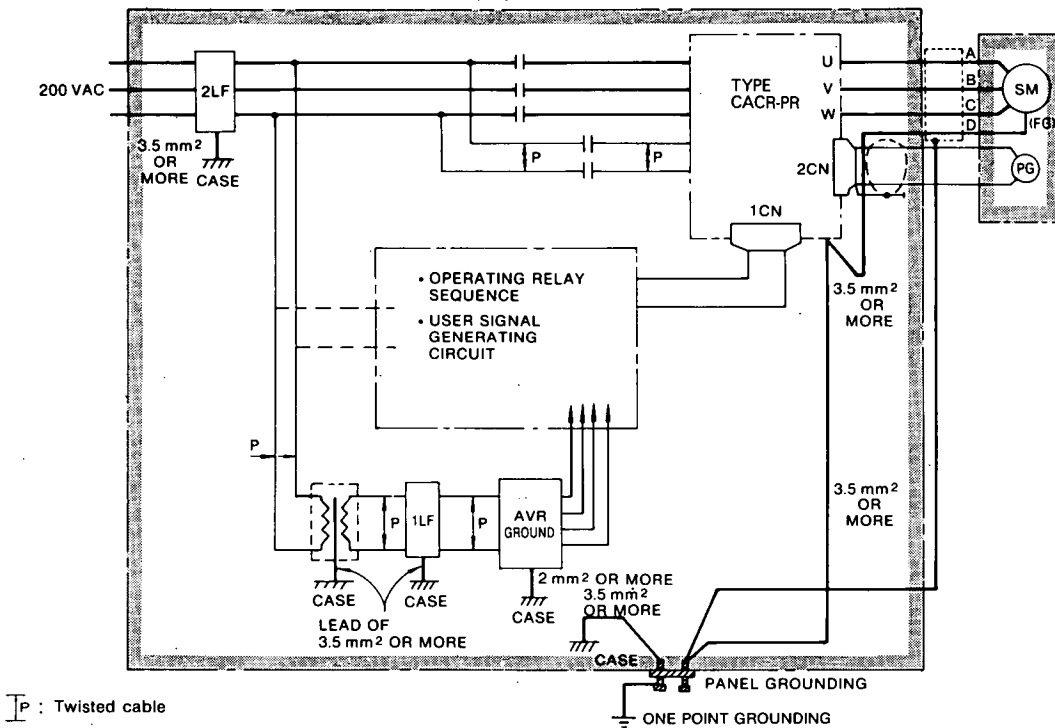

Notes:

1. Use wires of 3.5 mm² or more for grounding to the case (preferably flat-woven copper wire).

2. Connect line filters observing the precautions as shown in (2) "Noise filter installation"

Fig. 6. 19 Grounding Method

(2) Noise filter installation

When noise filters are installed to prevent noise from the power line, the block type must be used. The recommended noise filters are shown in Table 6.25. The power supply to peripherals also needs noise filters.

NOTE

If the noise filter connection is wrong, the effect decreases greatly. Observing the precautions, carefully connect them as shown in Figs. 6.20 to 6.23.

Table 6.25 Recommended Noise Filter

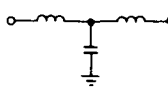
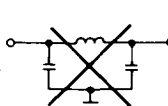
SERVOPACK Type CACR-	Applicable Noise Filter	Recommended Noise Filter	
		Type	Specifications
PR03BC PR05BC	 CORRECT	LF-305	Three-phase 200 VAC class, 5 A
PR07BC		LF-310	Three-phase 200 VAC class, 10 A
PR10BC PR15BC		LF-315	Three-phase 200 VAC class, 15 A
PR20BC	 WRONG	LF-320	Three-phase 200 VAC class, 20 A
PR30BC		LF-330	Three-phase 200 VAC class, 30 A
PR44BC		LF-340	Three-phase 200 VAC class, 40 A

Note: Noise filter made by Tokin Corp.

- (a) Separate the input and output leads. Do not bundle or run them in the same duct.

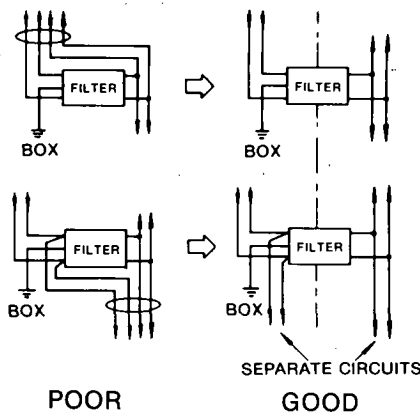

Fig. 6.20

- (b) Do not bundle the ground lead with the filter output line or other signal lines or run them in the same duct.

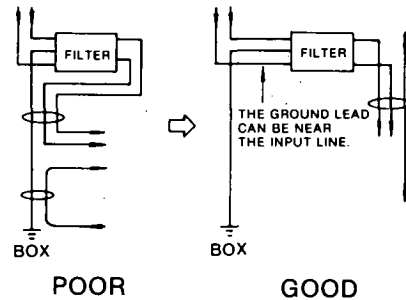

Fig. 6.21

- (c) Connect the ground lead singly to the box or the ground panel.

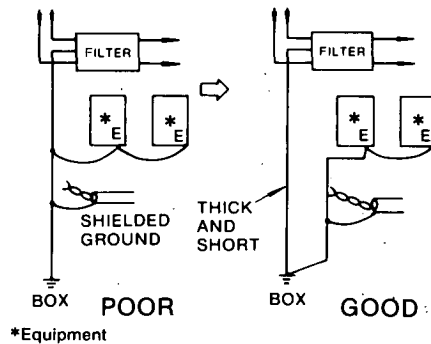

Fig. 6.22

- (d) If the control panel contains the filter, connect the filter ground and the equipment ground to the base of the control unit.

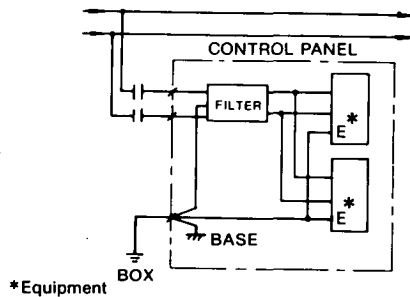

Fig. 6.23

6.11.2 Power Line Protection

The SERVOPACK is operated through the commercial power line (200V). To prevent power line accidents due to grounding error, contact error, or to protect the system from a fire, circuit breakers(MCCB) or fuses must be installed according to the number of SERVOPACKS used (Table 6.26).

A quick-melting fuse cannot be used, because the SERVOPACK uses a capacitor-input power supply and the charging current might inadvertently melt such a fuse.

6. 11. 2 Power Line Protection (Cont'd)

Table 6. 26 Power Supply Capacity and MCCB or Fuse Capacity

SERVOPACK Type CACR-	Power Capacity* per SERVOPACK	Current Capacity per MCCB or Fuse
PR03BC	0.65 kVA	5 A
PR05BC	1.1 kVA	5 A
PR07BC	1.5 kVA	8 A
PR10BC	2.1 kVA	8 A
PR15BC	3.1 kVA	10 A
PR20BC	4.1 kVA	12 A
PR30BC	6.0 kVA	18 A
PR44BC	8.0 kVA	24 A

*Values at rated load.

Note: For ground fault interrupter, specify the high-speed type. The time delay type is not adopted.

6. 12 APPLICATION

6. 12. 1 Connection for Reverse Motor Running

If the machine construction requires that the normal forward reference is used for reverse motor running and the normal reverse reference for forward running, short circuit across CN2-1 and CN2-7 of connector 2CN for the PG. In this case, change of motor and PG connection is not required. For forward reference, frequency dividing output from SERVOPACK forwards B-phase.

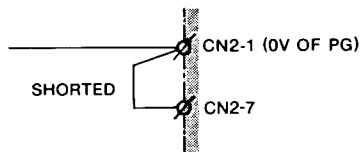
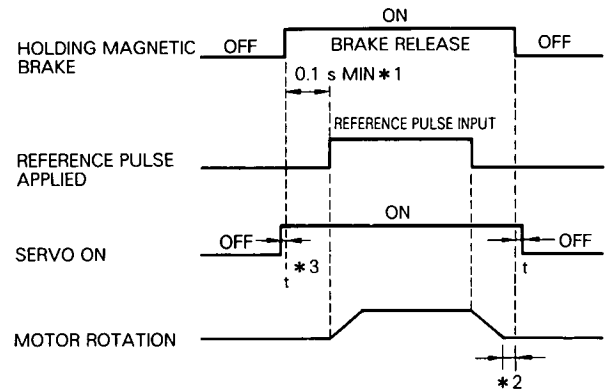

Fig. 6. 24

6. 12. 2 Use of Servomotor with Holding Magnetic Brake

When SERVOMOTOR with holding magnetic brake is used, use the following timing for ON and OFF signals. The holding magnetic brake is released by current condition.



- *1 Input speed reference 0.1s or more after the brake release reference has been input.
- *2 Apply brake after the motor has stopped completely. (Do not use the brake to decelerate the motor.)
- *3 "t" shows a delay time greater than the operating time(10ms) of one relay.

Note: Turn on SW4- ⑥ (installation of setting plug). Servo lock status after Servo OFF is held during approximately 200 ms.

Fig. 6. 25 Holding Magnetic Brake ON-OFF Timing

7. INSTALLATION AND WIRING

7.1 RECEIVING

This motor has been put through stringent tests at the factory before shipment. After unpacking, however, check for the following.

- Its nameplate ratings meet your requirements.
- It has sustained no damage while in transit.
- The output shaft can be hand-rotated freely. However, the brake-mounted motor does not rotate since it is shipped with the shaft locked.
- Fastening bolts and screws are not loose.

If any part of the motor is damaged or lost, immediately contact your YASKAWA representative giving full details and nameplate data.

7.2 INSTALLATION

7.2.1 SERVOMOTOR

AC SERVOMOTOR can be installed either horizontally or vertically.

(1) Before mounting

Wipe anticorrosive paint on shaft extension and flange surface with a cloth before connecting the motor to the driven machine. See Fig. 7.1.

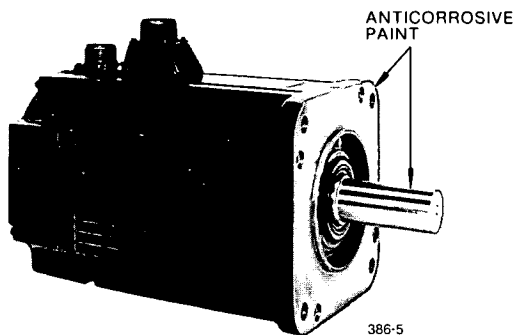

Fig. 7.1 Anticorrosive Paint to be Removed

(2) Location

Use the motor under the following conditions.

- Indoors
- Free from corrosive and/or explosive gases or liquids
- Ambient temperature: -10 to $+40^{\circ}\text{C}$
- Clean and dry
- Accessible for inspection maintenance and cleaning

If the AC SERVOMOTOR is subject to excessive water or oil droplets, protect the motor with a cover. The motor can withstand a small amount of splashed water or oil.

(3) Environmental conditions

Ambient Temperature: 0° to $+40^{\circ}\text{C}$

Storage Temperature: -20° to $+80^{\circ}\text{C}$

Humidity: 20% to 80% RH(non-condensing)

(4) Load coupling

True alignment of motor and driven machine is essential to prevent vibration, reduced bearing and coupling life, or shaft and bearing failures.

Use flexible coupling with direct drive. Alignment should be made in accordance with Fig. 7.2.

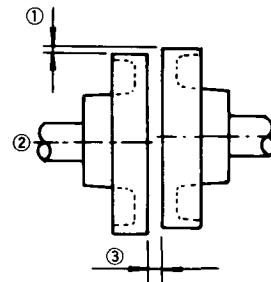

- ① Measure the gap between a straightedge and coupling halves at four equidistant points of the coupling. The each reading should not exceed 0.03 mm.
- ② Align the shafts.
- ③ Measure the gap between the coupling faces at four equidistant points around the coupling rim with a thickness gage. The maximum variation between any two readings should not exceed 0.03 mm.

Fig. 7.2 Alignment of Coupling

(5) Allowable bearing load

Avoid both thrust and radial loads to the motor shaft. If unavoidable, never exceed the values in Tables 4.1 to 4.3.

7.2.2 SERVOPACK

(1) Installation

The SERVOPACK type CACR-PR:XXXBC is a rack-mounted type as standard.

(2) Location

- When installed in a panel:

Keep the ambient temperature around SERVOPACK at 55°C or below.

- When installed near a heat source:

Keep the ambient temperature around SERVOPACK below 55°C.

- If subjected to vibration:

Mount the unit on shock absorbing material.

- If corrosive gases are present:

Avoid locations where corrosive gases exist since it may cause extensive damage over long use. Especially vulnerable are switching operations of contactors and relays.

- Unfavorable atmospheric conditions:

Select a location with minimum exposure to oil, water, hot air, high humidity, excessive dust or metallic particles.

(3) Mounting Direction

Mount the SERVOPACK unit vertically on the wall with main terminals being at the bottom to take advantage of natural air convection. (See Fig. 7.3(a).) Install it with setscrews tightened at four mounting holes in the unit base. To change to base-mounted type, change the support position as shown in Fig. 7.3(b). Mounting screws of base support are attached to the SERVOPACK.

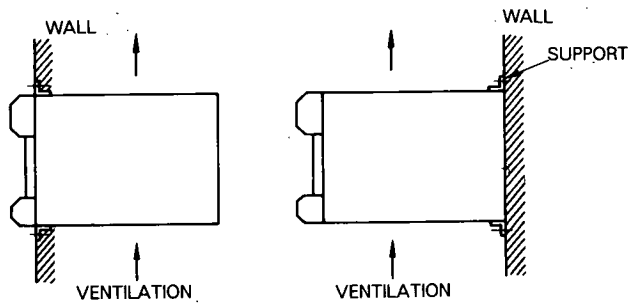

(a) Rack-mounted Type

(b) Base-mounted Type

Fig. 7.3 Mounting of SERVOPACK

7.3 WIRING

7.3.1 Rated Current and Cable Size

Tables 7.1 and 7.2 show external terminals, rated current, and cable sizes of the power unit and SERVOPACK, respectively. Select the type and size of cables to meet ambient conditions and current capacity. The cable size is calculated so that a bundle of three cables can bear the rated current at an ambient temperature of 40°C. Table 7.3 lists the type of cables.

Table 7.1 Rated Current

External Terminal	Type CACR Symbol	Rated Current A (Effective Current)								
		PR 03BC	PR 05BC	PR 07BC	PR 10BC	PR 15BC	PR 20BC	PR 30BC	PR 44BC	
On Line	Main Circuit Power Input	R, S, T	2	5	6	8	10	12	18	24
	Motor Connection	U, V, W	3.0	3.8	5.8	7.6	11.7	18.8	26.0	33.0
	Control Power Input	r, t	0.5							
Off Line	Control I/O Signal Connector	1CN	100 mA DC max							
	PG Signal Connector	2CN	100 mA DC max (500 mA DC for power line only)							
	Ground	⊥	—							

Table 7.2 Recommended Cable Size of SERVOPACK

External Terminal	Type CACR Symbol	Cable Size mm ²									
		PR 03BC	PR 05BC	PR 07BC	PR 10BC	PR 15BC	PR 20BC	PR 30BC	PR 44BC		
On Line	Main Circuit Power Input	R, S, T				HIV 2.0 or more		HIV 3.5 or more		HIV 5.5	HIV 5.5
	Motor Connection	U, V, W				HIV 2.0 or more		HIV 3.5 or more		HIV or more	HIV or more
	Control Power Input	r, t				HIV 1.25 or more					
Off Line	Control I/O Signal Connector	1CN				<ul style="list-style-type: none"> • Two-core twisted shielded cable • Core must be 0.2 mm² or more • Tin-plated soft-copper twisted cable 					
	PG Signal Connector	2CN				<ul style="list-style-type: none"> • Finished cable dimension: 16 dia or less for 1CN, 11 dia or less for 2CN 					
	Ground	⊥				HIV 2.0 or more					

Table 7.3 Cable

Type of Lead	Allowable Conductor Temperature
Vinyl Cable (PVC)	—
600 V Vinyl Cable (IV)	60
Special Heat-Resistant Cable (HIV)	75

Notes:

1. For main circuits, use cables of 600 V or more.
2. Where cables are bundled or run through a duct (unplasticized polyvinyl chloride conduit or metallic conduit), select the larger cable size than listed considering the current drop rate of the cables.
3. Where the ambient (panel inside) temperature is high (40°C to 60°C), use heat-resistant cables.

7.3.2 Wiring Precautions

SERVOPACK is a device for speed control of 3000:1, and signal level of several milli-volts or less. The following precautions should be taken when wiring.

(1) For signal lines and PG feedback lines, use twisted cables or multi-core shielded twisted-pair cables (Yaskawa Drawing No. DP8409123 or DE8400093).

Cable length is a maximum of 3 m for reference input lines and a maximum of 20 m for PG feedback lines. Use the shortest possible length.

(2) For ground line, cable should be as heavy as possible to provide Class 3 ground (ground resistance 100 Ω or less). Make sure to ground at one point. If the motor and machine are insulated, ground the motor.

(3) To prevent malfunction due to noise, take the following precautions:

- Place noise filters, SERVOPACK and I/O reference as near as possible to each other.
- Make sure to mount a surge suppressing circuit into the relay, electromagnetic contact, and solenoid coils.
- Run the power line and signal line, keeping the distance to 30 cm or more; do not run them in the same duct or in a bundle.
- When the same power is used for SERVOPACK, as for an electric welder or electrical discharge machine or when a high-frequency noise source is present in the vicinity, use filters in the power and input circuits.

(4) Remedy for Radio Frequency Interference (R.F.I)

SERVOPACK is not provided with protection from radio frequency interference. If the controller is adversely affected by radio waves, connect a noise filter to the power supply.

(5) The signal line uses cables whose cores are extremely fine (0.2 to 0.3 mm). Avoid using excessive force which may damage these cables.

7.3.3 Power Loss

The power loss of SERVOPACK is shown in Table 7.4.

Table 7.4 Power Loss at Rated Output

SERVOPACK Type CACR-	Output Current A	Power Loss			
		Main Circuit W	Regenerative Resistance W	Control Circuit W	Total W
PR03BC	3.0	20	10	60	90
PR05BC	3.8	40			110
PR07BC	5.8	60	20		140
PR10BC	7.6	70			150
PR15BC	11.7	80	40		160
PR20BC	18.8	100			200
PR30BC	26.0	160	80		300
PR44BC	33.0	210	100		370

Note: The regenerative resistor causes power loss when the motor is decelerated, but is negligible if the motor is not started and stopped frequently.

(2) With Brake

Taper Shaft

Drawing 1

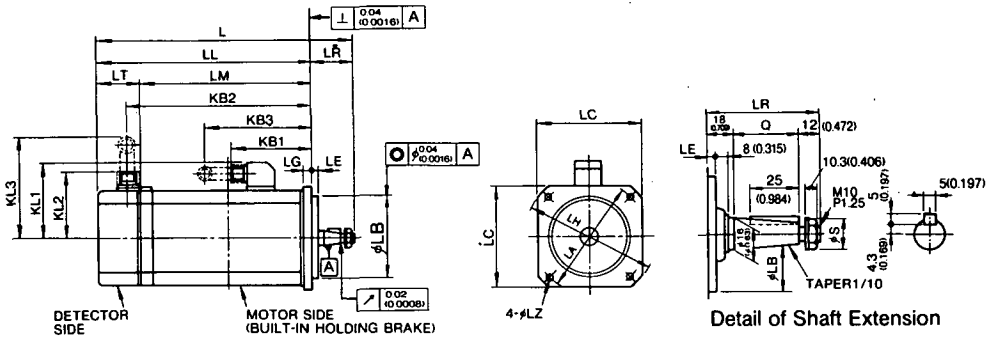

Straight Shaft

Drawing 2

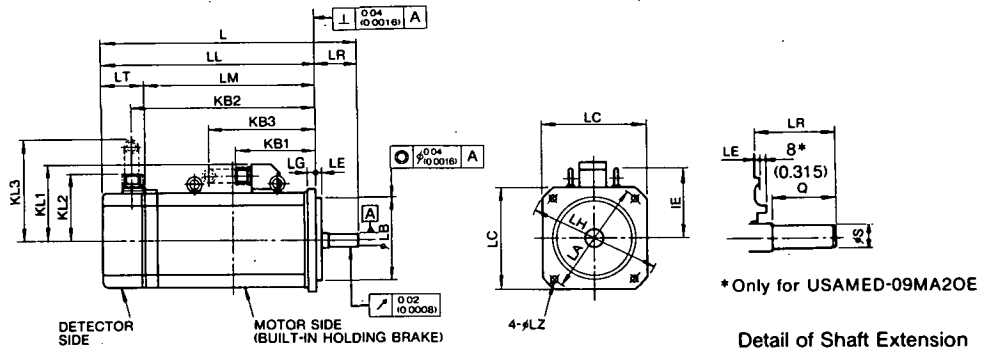

*Only for USAMED-09MA20E

Detail of Shaft Extension

AC SERVMOTOR Type USAMED-	Dwg No.	L	LL	LM	LR	LT	KB1	KB2	KB3	IE	KL1	KL2	KL3	Flange Surface						Shaft Extension			
														LA	LB	LC	LE	LG	LH	LZ	S	Q	
03MA10E*	1	316 (12.441)	258 (10.157)	214 (8.425)				233 (9.173)														21 (0.827)	28 (1.102)
06MA10E*	1	362 (14.252)	304 (11.969)	260 (10.236)	58 (2.283)	44 (1.732)	116 (4.567)	279 (10.984)	158 (6.220)		113 (4.449)	93 (3.661)	147 (5.787)	145 (5.709)	110 ^{-0.025} _(4.331 -0.00128)	130 (5.118)	6 (0.236)	12 (0.472)	165 (6.496)	9 (0.354)		22 ^{-0.013} _(0.866 -0.00012)	40 (1.575)
09MA20E*	2	452 (17.795)	394 (15.512)	350 (13.780)				369 (14.529)															
12MA20E	2	426 (16.772)	347 (13.661)	292 (11.496)				311 (12.244)															
20MA20E	2	490 (19.291)	411 (16.181)	356 (14.016)	79 (3.110)	55 (2.165)	165 (6.496)	375 (14.764)	220 (8.661)	124 (4.882)	143 (5.630)	110 (4.331)	171 (6.732)	200 (7.874)	114.3 ^{-0.025} _(4.5 -0.00094)	180 (7.087)	3.2 (0.126)	18 (0.709)	230 (9.055)	13.5 (0.531)		35 ^{+0.01} _(1.378 +0.00034)	76 (2.992)
30MA20E	2	571 (22.480)	492 (19.370)	437 (17.205)				456 (17.953)															

AC SERVMOTOR Type USAMED-	Dwg No.	Approx Mass kg (lb)	Brake Torque N·m (lb-in)	Connector Types for Motor and Brake				Optical Encoder Connector Types			
				Receptacle	L-type Plug	Straight Plug	Cable Clamp	Receptacle	L-type Plug	Straight Plug	Cable Clamp
03MA10E*	1	11.5 (25)	5.88 (52.1)	MS 3102 A 20 -15 P	MS 3108 B 20 -15 S	MS 3106 B 20 -15 S	MS 3057 -12 A	MS 3102 A 20 -29 P	MS 3108 B 20 -29 S	MS 3106 B 20 -29 S	MS 3057 -12 A
06MA10E*	1	15 (33)									
09MA20E*	2	23 (51)									
12MA20E	2	30 (66)	35.28 (312.5)	MS 3102 A 24 -10 P	MS 3108 B 24 -10 S	MS 3106 B 24 -10 S	MS 3057 -16 A	MS 3102 A 20 -29 P	MS 3108 B 20 -29 S	MS 3106 B 20 -29 S	MS 3057 -12 A
20MA20E	2	37 (81)									
30MA20E	2	49 (108)									

* Not provided with an eyebolt.

Notes:

- Optical encoder (6000 pulses/rev) is used as a detector.
- Vibration: 15 μm or below.

3. Plug and clamp are not attached for receptacle connection.

4. Power supply for brake is 90 VDC.

5. For type USAMED-44MA20E, contact your YASKAWA representative.

(3) Shaft Extension of Straight Shaft with Keyway

Both SERVMOTORS without brake and with brake have the same dimensions except for shaft extension. Shaft extensions are shown below:

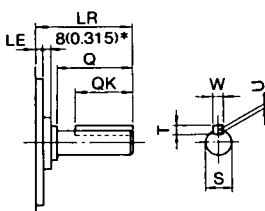

*Only for USAMED-03MA20E to-09MA20E

AC SERVMOTOR Type USAMED-	Without Brake	With Brake	LR	LE	Shaft Extension					
					S	Q	QK	T	U	W
03MA2K	03MA2KE				19 ^{-0.013} _(0.748 -0.00012)	40 (1.575)	25 (0.984)	5 (0.197)	3 (0.118)	5 (0.197)
06MA2K	06MA2KE	58 (2.283)	6 (0.236)		22 ^{-0.013} _(0.866 -0.00012)			6 (0.236)	3.5 (0.138)	6 (0.236)
09MA2K	09MA2KE									
12MA2K	12MA2KE									
20MA2K	20MA2KE	79 (3.11)	3.2 (0.126)		35 ^{+0.01} _(1.378 +0.00034)	76 (2.992)	60 (2.362)	8 (0.315)	5 (0.197)	10 (0.394)
30MA2K	30MA2KE									
44MA2K	44MA2KE	110 (4.331)			42 ^{-0.016} _(1.654 -0.00063)	110 (4.331)	90 (3.543)			12 (0.472)

8.2 SERVOMOTOR: F SERIES

(1) Standard

Taper Shaft

Drawing 1

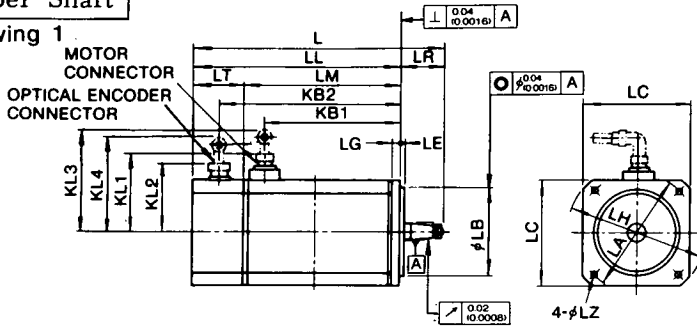

Types USAFED-02FA1, and -03FA1

Types USAFED-05FA1, and -09FA1

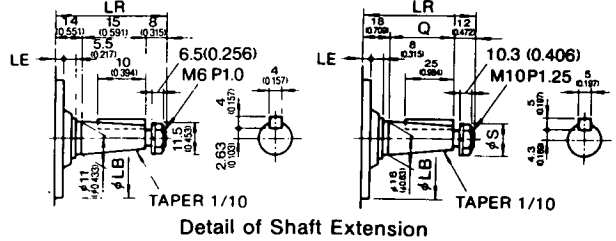

Detail of Shaft Extension

Straight Shaft

Drawing 2

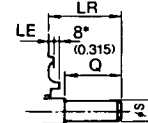
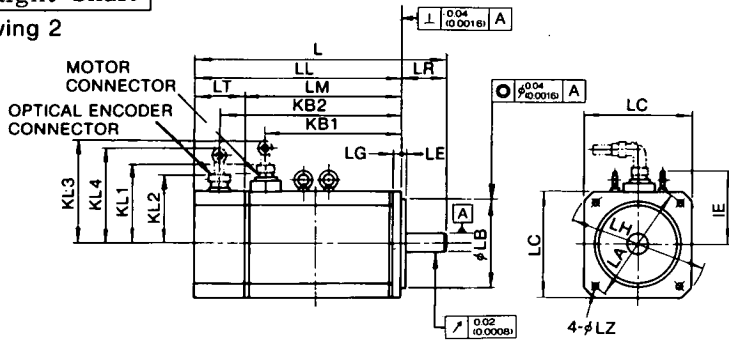

* Only for USAFED-13FA2
Detail of Shaft Extension

AC SERVO MOTOR Type USAFED-	Dwg No.	L	LL	LM	LR	LT	KB1	KB2	IE	KL1	KL2	KL3	KL4	Flange Surface						
														LA	LB	LC	LE	LG	LH	LZ
02FA1	1	190 (7.480)	153 (6.024)	113 (4.449)	37	40 (1.575)	89.5 (3.524)	132 (5.197)	-	76 (2.992)	89 (3.503)	126 (4.961)	139 (5.472)	100 (3.937)	80 (3.150)	90 (3.543)	4 (0.157)	7 (0.276)	120 (4.724)	6.6 (0.260)
03FA1	1	236 (9.291)	199 (7.835)	159 (6.260)	58	46 (1.811)	124 (4.882)	124 (6.929)	-	112 (4.409)	93 (3.661)	168 (6.614)	158 (6.22)	145 (5.709)	110 (4.331)	130 (5.118)	6 (0.236)	12 (0.472)	165 (6.496)	9 (0.354)
05FA1*	1	261 (10.276)	203 (7.992)	157 (6.181)	79	58 (2.283)	181 (7.126)	233 (9.137)	-	137 (5.394)	110 (4.331)	202 (7.953)	175 (6.89)	200 (7.874)	114.3 (4.5)	180 (7.087)	3.2 (0.126)	18 (0.709)	230 (9.065)	13.5 (0.531)
09FA1*	1	318 (12.52)	260 (10.236)	214 (8.425)	79	58 (2.283)	250 (9.843)	322 (12.677)	-	137 (5.394)	110 (4.331)	202 (7.953)	175 (6.89)	200 (7.874)	114.3 (4.5)	180 (7.087)	3.2 (0.126)	18 (0.709)	230 (9.065)	13.5 (0.531)
13FA2*	2	406 (15.984)	348 (13.701)	302 (11.890)	79	58 (2.283)	171 (6.732)	232 (9.134)	124 (4.882)	137 (5.394)	110 (4.331)	202 (7.953)	175 (6.89)	200 (7.874)	114.3 (4.5)	180 (7.087)	3.2 (0.126)	18 (0.709)	230 (9.065)	13.5 (0.531)
20FA2*	2	350 (13.78)	271 (10.669)	213 (8.386)	79	58 (2.283)	229 (9.016)	290 (11.417)	124 (4.882)	137 (5.394)	110 (4.331)	202 (7.953)	175 (6.89)	200 (7.874)	114.3 (4.5)	180 (7.087)	3.2 (0.126)	18 (0.709)	230 (9.065)	13.5 (0.531)
30FA2	2	408 (16.063)	329 (12.953)	271 (10.669)	79	58 (2.283)	314 (12.326)	375 (14.764)	124 (4.882)	137 (5.394)	110 (4.331)	202 (7.953)	175 (6.89)	200 (7.874)	114.3 (4.5)	180 (7.087)	3.2 (0.126)	18 (0.709)	230 (9.065)	13.5 (0.531)
44FA2	2	493 (19.409)	414 (16.299)	356 (14.016)	79	58 (2.283)	314 (12.326)	375 (14.764)	124 (4.882)	137 (5.394)	110 (4.331)	202 (7.953)	175 (6.89)	200 (7.874)	114.3 (4.5)	180 (7.087)	3.2 (0.126)	18 (0.709)	230 (9.065)	13.5 (0.531)

AC SERVO MOTOR Type USAFED-	Dwg No.	Shaft Extension		Approx Mass kg (lb)	Motor Connector Types				Optical Encoder Types			
		S	Q		Receptacle	L-type Plug	Straight Plug	Cable Clamp	Receptacle	L-type Plug	Straight Plug	Cable Clamp
02FA1	1	11.5	15	3.5 (8)	MS 3102 A 14 S	MS 3108 B 14 S	MS 3106 B 14 S	MS 3057	MS 3102 A 20 -29 P	MS 3108 B 20 -29 S	MS 3106 B 20 -29 S	MS 3057 -12 A
03FA1	1	0.453	0.591	4 (9)	-2 S	-2 S	-2 S	-6 A				
05FA1*	1	21	28	8.5 (19)	MS 3102 A 18 -10 P	MS 3108 B 18 -10 S	MS 3106 B 18 -10 S	MS 3057 -10 A				
09FA1*	1	0.827	1.102	13 (29)								
13FA2*	2	0.866	1.575	20 (44)	MS 3102 A 22 -22 P	MS 3108 B 22 -22 S	MS 3106 B 22 -22 S	MS 3057 -12 A				
20FA2*	2	0.000012	0.000012	22 (48)								
30FA2	2	1.378	2.992	29 (64)								
44FA2	2	0.000094	0.000094	41 (90)								

* Not provided with an eyebolt.

Notes:

1. Optical encoder (6000 pulses/rev) is used as a detector.
2. Vibration: 15 μm or below.
3. Plug and clamp are not attached for receptacle connection.

(2) With Brake

Taper Shaft

Drawing 1

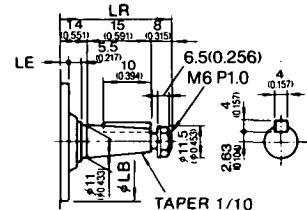
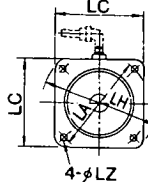
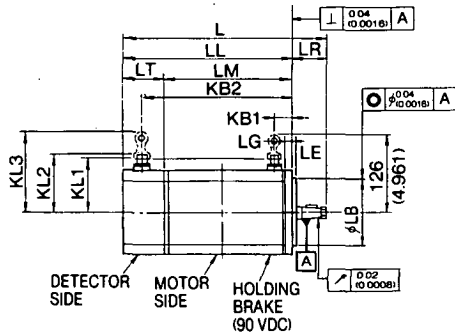

Detail of Shaft Extension

Straight Shaft

Drawing 2

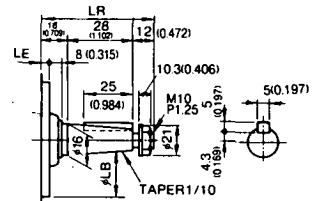
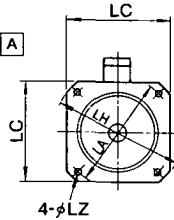
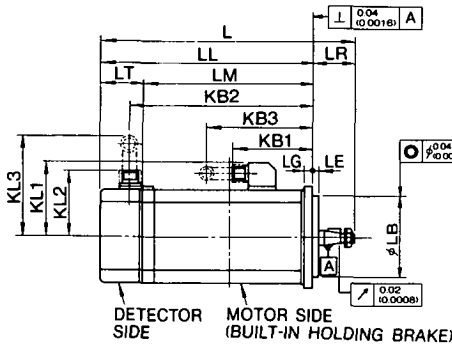

Detail of Shaft Extension

Straight Shaft

Drawing 3

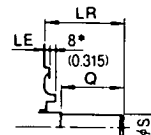
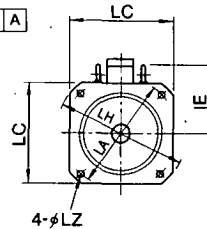
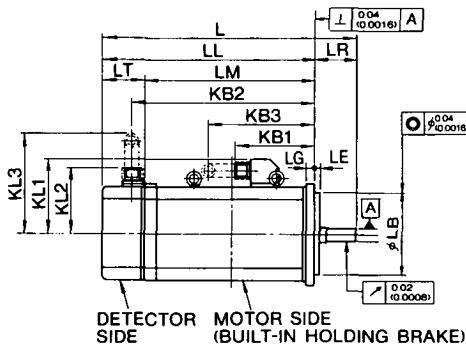

* Only for USAFED-13FA20E

Detail of Shaft Extension

8.2 SERVOMOTOR: F SERIES (Cont'd)

AC SERVOMOTOR Type USAFED-	Dwg No.	L	LL	LM	LR	LT	KB1	KB2	KB3	IE	KL1	KL2	KL3	Flange Surface							Shaft Extension		
														LA	LB	LC	LE	LG	LH	LZ	S	Q	
02FA10E	1	236 (9.291)	199 (7.835)	159 (6.260)	37	40	24	178 (7.008)	-		76 (2.992)	89 (3.504)	154 (6.063)	100 (3.937)	80 ⁰ _{-0.010} (3.150 ⁰ _{-0.00118})	90 (3.543)	4 (0.157)	7 (0.276)	120 (4.724)	6.6 (0.260)	See Drawing 1.		
03FA10E	1	286 (11.260)	249 (9.803)	209 (8.228)				228 (8.976)															
05FA10E*	1	316 (12.441)	258 (10.157)	214 (8.125)	58	44	116	233 (9.173)	158	-	113 (4.449)	93 (3.661)	147 (5.787)	145 (5.709)	110 ⁰ _{-0.025} (4.331 ⁰ _{-0.00438})	130 (5.118)	6 (0.236)	12 (0.472)	165 (6.496)	9 (0.354)			
09FA10E*	1	362 (14.252)	304 (11.969)	260 (10.236)				279 (10.984)															
13FA20E*	2	452 (17.780)	394 (15.512)	350 (13.780)	79	55	165	369 (14.528)	220	124	143 (5.630)	110 (4.331)	171 (6.732)	200 (7.874)	114.3 ⁰ _{-0.025} (4.5 ⁰ _{-0.00398})	180 (7.087)	3.2 (0.126)	18 (0.709)	230 (9.065)	13.5 (0.531)			
20FA20E	2	426 (16.772)	347 (13.661)	292 (11.496)				311 (12.244)															
30FA20E	2	490 (19.291)	411 (16.181)	356 (14.016)	375 (14.764)																		
44FA20E	2	571 (22.48)	492 (19.37)	437 (17.205)	456 (17.953)																		

AC SERVOMOTOR Type USAFED-	Dwg No.	Approx Mass kg (lb)	Brake Torque N·m (lb·in)	Connector Types for Motor and Brake				Optical Encoder Connector Types			
				Receptacle	L-type Plug	Straight Plug	Cable Clamp	Receptacle	L-type Plug	Straight Plug	Cable Clamp
02FA10E	1	4.4 (10)	0.98 (8.7)	MS 3102 A 14 S	MS 3108 B 14 S	MS 3106 B 14 S	MS 3057	MS 3102 A 20 -29 P	MS 3108 B 20 -29 S	MS 3106 B 20 -29 S	MS 3057 -12 A
03FA10E	1	5 (11)		-6 P	-6 S	-6 S	-6 A				
05FA10E*	1	11.5 (25)	5.88 (52.1)	MS 3102 A 20	MS 3108 B 20	MS 3106 B 20	MS 3057				
09FA10E*	1	15 (33)		-15 P	-15 S	-15 S	-12 A				
13FA20E*	2	23 (51)	5.88 (52.1)	MS 3102 A 24	MS 3108 B 24	MS 3106 B 24	MS 3057				
20FA20E	2	30 (66)		-10 P	-10 S	-10 S	-16 A				
30FA20E	2	37 (81)									
44FA20E	2	49 (108)									

* Not provided with an eyebolt.

Notes:

- Optical encoder (6000 pulses/rev) is used as a detector.
- Vibration: 15 μm or below.

- Plug and clamp are not attached for receptacle connection.
- Power supply for brake is 90 VDC.

(3) Shaft Extension of Straight Shaft with Keyway

Both SERVOMOTORS with brake and without brake have the same dimensions except for shaft extension. Shaft extensions are shown below:

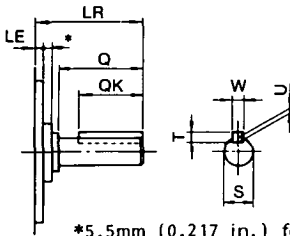

*5.5mm (0.217 in.) for USAFED-02FA2[] and 03FA2[]
8mm (0.315 in.) for USAFED-05FA2[] to 13FA2[]

AC SERVOMOTOR Type USAMED-		LR	LE	Shaft Extension					
Without Brake	With Brake			S	Q	QK	T	U	W
02FA2K	02FA2KE	37 (1.457)	4 (0.157)	14 ⁰ _{-0.011} (0.551 ⁰ _{-0.00043})	25 (0.984)	15 (0.591)	5 (0.197)	3 (0.118)	5 (0.197)
03FA2K	03FA2KE			19 ⁰ _{-0.013} (0.748 ⁰ _{-0.00512})	40 (1.575)	25 (0.984)			
05FA2K	05FA2KE	58 (2.283)	6 (0.236)	22 ⁰ _{-0.013} (0.866 ⁰ _{-0.00512})	6 (0.236)	3.5 (0.138)	6 (0.236)	8 (0.315)	5 (0.197)
09FA2K	09FA2KE			35 ^{+0.01} ₀ (1.378 ^{+0.000394} ₀)					
13FA2K	13FA2KE	79 (3.11)	3.2 (0.126)	76 (2.992)	60 (2.362)	8 (0.315)	5 (0.197)	10 (0.394)	
20FA2K	20FA2KE								
30FA2K	30FA2KE								
44FA2K	44FA2KE								

8.3 SERVOMOTOR: S SERIES

(1) Standard

Straight Shaft

- Types USASEM-02AE2 (Note 1), -03AE2, -05AE2

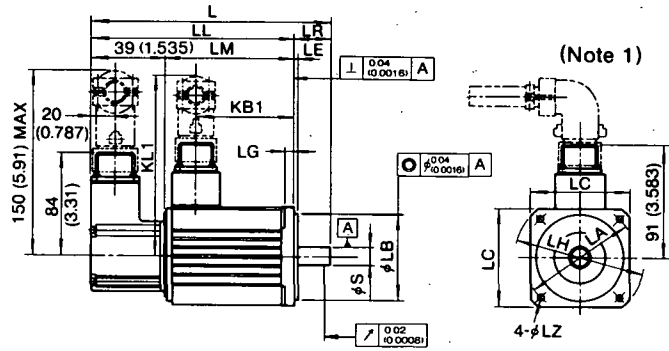

AC Servomotor Type USASEM-	L	LL	LM	LR	KB1	KL1	Flange Surface & Shaft Extension								Approx Mass kg (lb)	
							LA	LB	LC	LE	LG	LH	LZ	S		
02AE2	164.5 (6.476)	134.5 (5.295)	95.5 (3.760)	30 (1.181)	72.5 (2.854)	—	80 (3.150)	50 (1.969)	65 (2.559)	3 (0.118)	6 (0.236)	90 (3.543)	5 (0.197)	8 (0.315)	14 (0.5512)	1.5 (3.3)
03AE2	178.5 (7.027)	148.5 (5.846)	109.5 (4.311)	30 (1.181)	79 (3.11)	145 (5.708)	90 (3.543)	70 (2.756)	80 (3.15)	3 (0.118)	8 (0.315)	105 (4.134)	6 (0.236)	14 (0.5512)	14 (0.5512)	2.7 (5.96)
05AE2	200.5 (7.893)	170.5 (6.712)	131.5 (5.177)	30 (1.181)	101 (3.976)	145 (5.708)	90 (3.543)	70 (2.756)	80 (3.15)	3 (0.118)	8 (0.315)	105 (4.134)	6 (0.236)	14 (0.5512)	14 (0.5512)	3.3 (7.28)

Notes:

- Drawout construction of Type USASEM-02AE2 is waterproof gland method. Therefore, connector part differs from figure above. For details, request another dimensions to YASKAWA representative.
- Optical encoder (1500 pulses/rev) is used as a detector.
- Vibration: 15 μm or below.
- Plug and clamp are not attached for receptacle connection.

Taper Shaft

- Types USASEM-08AC1, -15AC1, -30AC1

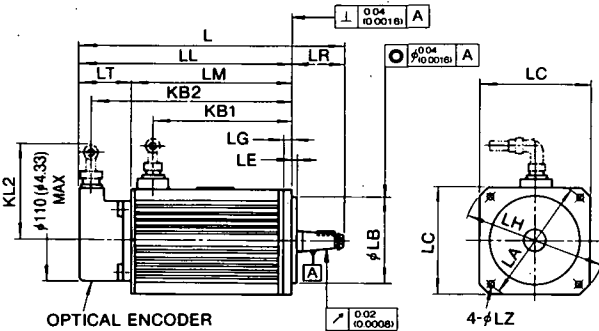

Types USASEM-08AC1, and -30AC1

Type USASEM-15AC1

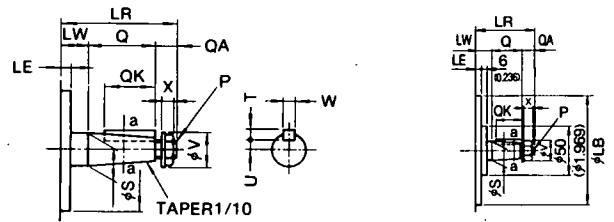

Detail of Shaft Extension

AC SERVO MOTOR Type USASEM-	L	LL	LM	LT	LR	KB1	KL1	KL2	Flange Surface								Shaft Extension									
									LA	LB	LC	LE	LG	LH	LZ	LW	Q	QK	QA	X	S	V	P	U	W	T
08AC1	257 (10.118)	199 (7.835)	148.5 (5.847)	50.5 (1.988)	58 (2.283)	115 (4.527)	170 (6.693)	150 (5.906)	130 (5.118)	110 (4.3308)	120 (4.724)	3 (0.118)	10 (0.394)	155 (6.1)	9 (0.354)	18 (0.709)	28 (1.102)	25 (0.984)	12 (0.472)	10.3 (0.406)	16 (0.63)	21 (0.827)	M10 P1.25	4.3 (0.1693)	5 (0.197)	5 (0.197)
15AC1	317.5 (12.5)	259.5 (10.217)	203.5 (8.013)	56 (2.206)	58 (2.283)	166.5 (6.555)	177 (6.969)	163 (6.413)	145 (5.708)	110 (4.3308)	130 (5.118)	6 (0.236)	12 (0.472)	165 (6.496)	9 (0.354)	18 (0.709)	28 (1.102)	25 (0.984)	12 (0.472)	10.3 (0.406)	19 (0.748)	21 (0.827)	M10 P1.25	5.8 (0.2283)	5 (0.197)	5 (0.197)
30AC1	366 (14.41)	296 (11.654)	240 (9.45)	56 (2.206)	70 (2.756)	206 (8.11)	205 (8.071)	165 (6.496)	200 (7.874)	114.3 (4.5)	180 (7.09)	6 (0.236)	18 (0.708)	230 (9.055)	13.5 (0.531)	20 (0.788)	36 (1.417)	32 (1.259)	14 (0.551)	12.5 (0.492)	22 (0.866)	24 (0.945)	M12 P1.25	6.6 (0.2598)	6 (0.236)	6 (0.236)

Notes:

- Optical encoder (2500 pulses/rev) is used as a detector.
- Vibration: 15 μm or below.
- Hexagon socket head bolts should be used to mount the motor.
- Plug and clamp are not attached for receptacle connection.
- Dimensions of the keyway are based on JIS (Japanese Industrial Standard) B1301 "Sunk keys and Their Corresponding keyways (close keys)."

AC SERVO MOTOR Type USASEM-	Approx Mass kg (lb)	Motor Connector Types				Optical Encoder Connector Types			
		Receptacle	L-type Plug	Straight Plug	Cable Clamp	Receptacle	L-type Plug	Straight Plug	Cable Clamp
03AE2	2.7 (5.95)	MS 3102 A 18	MS 3108 B 18	MS 3106 B 18	MS 3057-10 A	MS 3102 A 20 -29 P	MS 3108 B 20 -29 S	MS 3106 B 20 -29 S	MS 3057-12 A
05AE2	3.3 (7.28)	-10 P	-10 S	-10 S					
08AC1	5.8 (12.8)	MS 3102 A 20 -4 P	MS 3108 B 20 -4 S	MS 3106 B 20 -4 S	MS 3057-12 A				
15AC1	11 (24.25)								
30AC1	24 (52.9)								

Note: When plugs or clamps are required, contact your YASKAWA representative. The following connections are provided: soldered type MS and solderless type JA.

8.3 SERVOMOTOR: S SERIES (Cont'd)

(2) With Brake

Straight Shaft

- Types USASEM-02AE2OB (Note 1), -03AE2OB, -05AE2OB

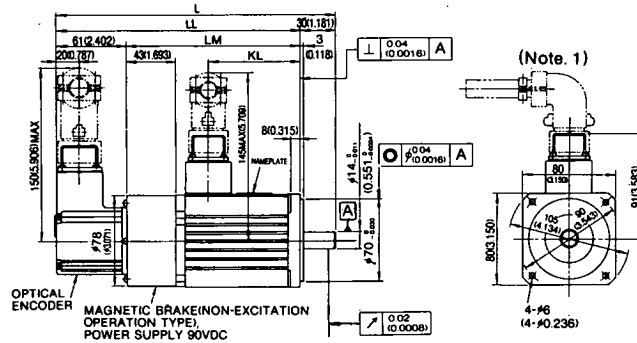

AC SERVOMOTOR Type USASEM-	L	LL	LM	KL	Magnetic Brake			Approx Mass kg (lb)
					Type	Inertia kg·m ² × 10 ⁻⁴ (lb·in ²)	Static Friction Torque N·m (lb·in)	
02AE2OB	228 (8.976)	198 (7.795)	137 (5.394)	72.5 (2.854)	MSB/ 90-10	0.016 (0.0144 × 10 ⁻³)	0.98 (8.680)	2.2 (4.9)
03AE2OB	241 (9.488)	211 (8.307)	150 (5.906)	79 (3.110)	MSB/ 90-10	0.016 (0.0144 × 10 ⁻³)	0.98 (8.680)	3.5 (7.7)
05AE2OB	263 (10.354)	233 (9.173)	172 (6.772)	101 (3.976)	MSB/ 90-20	0.016 (0.0144 × 10 ⁻³)	1.764 (15.623)	4.1 (9.0)

Notes:

- Drawout construction of Type USASEM-02AE2OB is waterproof gland method. Therefore, connector part differs from figure above. For details, request another dimensions to YASKAWA representative.
- Optical encoder (1500 pulses/rev) is used as a detector.
- Vibration: 15 μm or below.
- Plug and clamp are not attached for receptacle connection.
- Power supply for brake is 90VDC.

Taper Shaft

- Types USASEM -08AC1OB, -15AC1OB, -30AC1OB

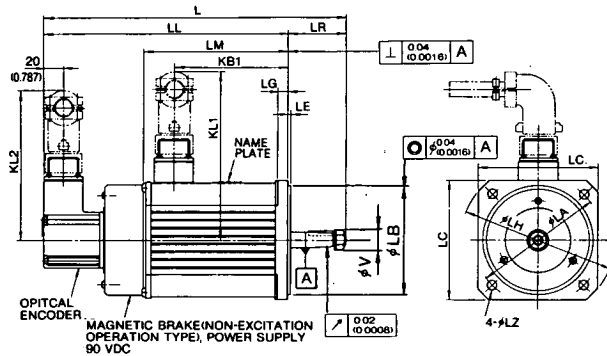

Types USASEM-08AC1OB,
and -30AC1OB

Type USASEM-15AC1OB

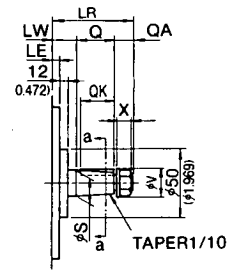
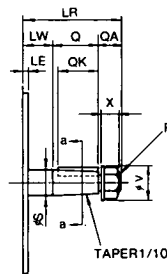

Detail of Shaft Extension

AC SERVOMOTOR Type USASEM-	L	LL	LM	LR	KB1	KL1	KL2	Flange Surface						Shaft Extension					
								LA	LB	LC	LE	LG	LH	LZ	LW	Q	QK	QA	X
08AC1OB	305 (12.008)	247 (9.724)	146 (5.748)	58 (2.283)	115 (4.527)	170 (6.693)	150 (5.906)	130 (5.118)	110 ^{-0.035} (4.3308 ^{-0.0013})	120 (4.724)	3 (0.118)	10 (0.394)	155 (6.1)	9 (0.354)	18 (0.709)	28 (1.102)	25 (0.984)	12 (0.472)	10.3 (0.406)
15AC1OB	377.5 (14.862)	319.5 (12.578)	197.5 (7.776)	58 (2.283)	166.5 (6.555)	177 (6.969)	163 (6.413)	145 (5.71)	110 ^{-0.035} (4.3308 ^{-0.0013})	130 (5.118)	6 (0.236)	12 (0.472)	165 (6.496)	9 (0.354)	18 (0.709)	28 (1.102)	25 (0.984)	12 (0.472)	10.3 (0.406)
30AC1OB	432 (17.008)	362 (14.252)	240 (9.449)	70 (2.756)	206 (8.11)	205 (8.071)	165 (6.496)	200 (7.874)	114.3 ^{-0.040} (4.5 ^{-0.00156})	180 (7.087)	6 (0.236)	18 (0.709)	230 (9.055)	13.5 (0.531)	20 (0.788)	36 (1.417)	32 (1.259)	14 (0.551)	12.5 (0.492)

AC SERVOMOTOR Type USASEM-	Shaft Extension						Approx Mass kg (lb)	Magnetic Brake Specifications			
	S	V	P	U	W	T		Type	Inertia kg·m ² × 10 ⁻⁴ (lb·in ²)	Static Friction Torque N·m (lb·in)	Voltage VDC
08AC1OB	16 (0.63)	21 (0.827)	M10 P 1.25	4.3 ^{-0.1} (0.1693 ^{-0.0039})	5 (0.197)	5 (0.197)	7 (15.5)	SCFB/ 90-30	0.54 (0.4751 × 10 ⁻³)	2.94 (26)	90
15AC1OB	19 (0.748)	21 (0.827)	M10 P 1.25	5.8 ^{-0.1} (0.2283 ^{-0.0039})	5 (0.197)	5 (0.197)	12.5 (27.6)	SCFB/ 90-60	0.67 (0.5949 × 10 ⁻³)	5.88 (52)	90
30AC1OB	22 (0.866)	24 (0.945)	M12 P 1.25	6.6 ^{-0.1} (0.2598 ^{-0.0039})	6 (0.236)	6 (0.236)	25.5 (56.2)	SCFB/ 90-120	0.67 (0.5949 × 10 ⁻³)	11.76 (104)	90

Notes:

- Optical encoder (2500 pulses/rev) is used as a detector.
- Vibration: 15 μm or below.
- Plug and clamp are not attached for receptacle connection.
- Dimensions of the keyway are based on JIS (Japanese Industrial Standard) B1301 "Sunk keys and Their Corresponding keyways (Close keys)."

AC SERVOMOTOR Type USASEM-	Connector Types for Motor + Brake			Detector Connector Types		
	Receptacle	L-type Plug	Cable Clamp	Receptacle	L-type Plug	Cable Clamp
03AE2OB, 05AE2OB	MS 3102 A 18 -12 P	MS 3108 B 18 -12 S	MS 3057 -10 A	MS 3102 A 20 -29 P	MS 3108 B 20 -29 S	MS 3057 -12 A
08AC1OB, 15AC1OB, 30AC1OB	MS 3102 A 20 -17 P	MS 3108 B 20 -17 S	MS 3057 -12 A			

(3) Shaft Extension of Straight Shaft

SERVOMOTOR proper is the same dimensions as standard SERVOMOTOR in S series except for dimension L. See Par. 8.3 (1). Details of shaft extension are shown below:

• With brake
Type USASEM-08AC20B

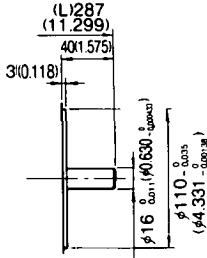

• With brake
Type USASEM-15AC20B

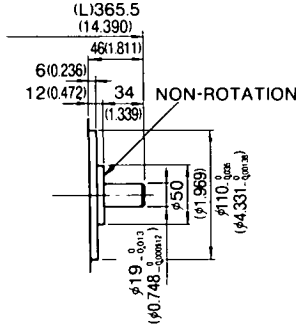

• With brake
Type USASEM-30AC20B

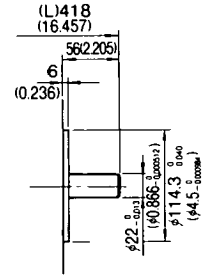

(4) Shaft Extension of Straight Shaft with Keyway

SERVOMOTOR proper is the same dimensions as standard SERVOMOTOR in S series, but dimensions L of type USASEM-08AC2K [] or higher is the different dimensions. See Par. 8.3 (1). Details of shaft extension are shown below.

• Types USASEM-03AE2K, -05AE2K*
Types USASEM-03AE2KB, -05AE2KB†

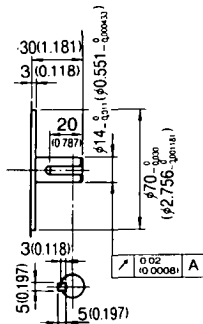

• Type USASEM-08AC2K*
Type USASEM-08AC2KB†

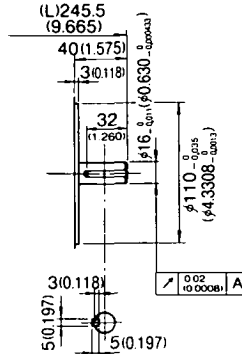

• Type USASEM-15AC2K*
Type USASEM-15AC2KB†

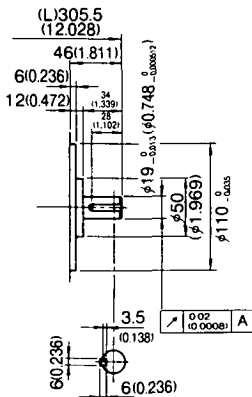

• Type USASEM-30AC2K*
Type USASEM-30AC2KB†

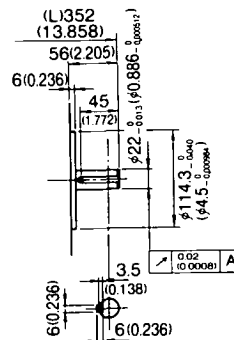

* Without brake
† With brake

8.3 SERVOMOTOR: S SERIES (Cont'd)

(5) Shaft Extension of Straight Shaft with Shaft Seal

SERVOMOTOR proper is the same dimensions as standard SERVOMOTOR in S series. See Par. 8.3 (1). Details of shaft extension are shown below:

- Without brake
Types USASEM-03AE2S, -05AE2S

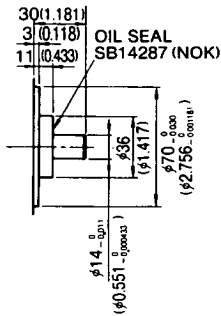

(6) Shaft Extension of Straight Shaft with Keyway and Shaft Seal

SERVOMOTOR proper is the same dimensions as standard SERVOMOTOR in S series. See Par. 8.3 (1). Details of shaft extension are shown below:

- Without brake
Types USASEM-03AE2T, -05AE2T

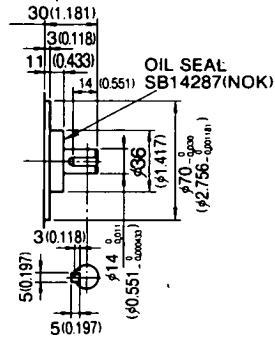

(7) Shaft Extension of Taper Shaft with Shaft Seal

SERVOMOTOR proper is the same dimensions as standard SERVOMOTOR in S series. See Par. 8.3 (1). Details of shaft extension are shown below:

- Without brake
Type USASEM-08AC1S

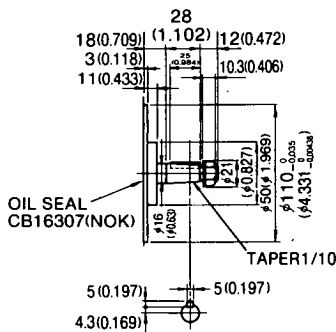

- Without brake
Type USASEM-15AC1S

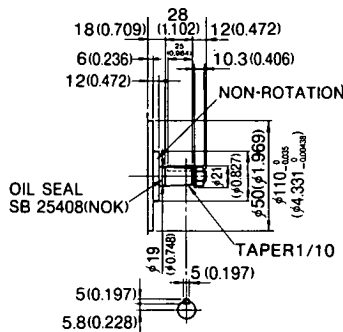

- Without brake
Type USASEM-30AC1S

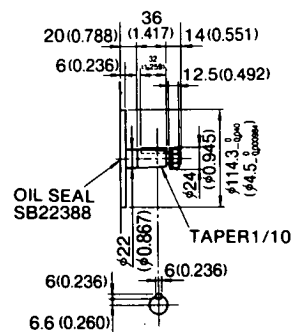

8.4 SERVOPACK

(1) Types CACR-PR03BC to 15BC

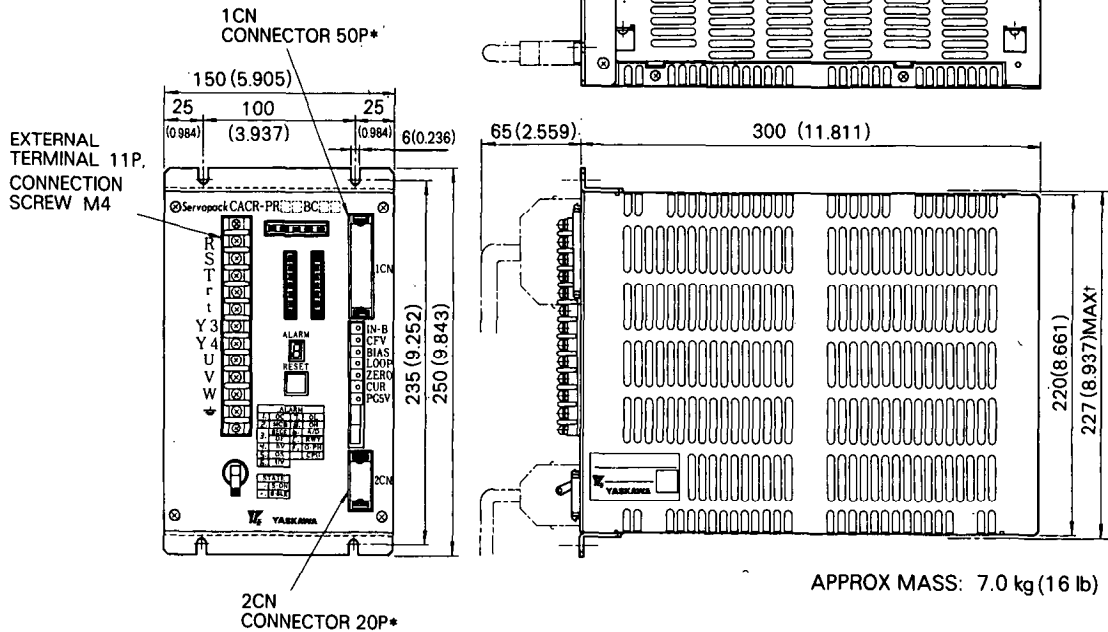

(2) Types CACR-PR20BC to 44BC

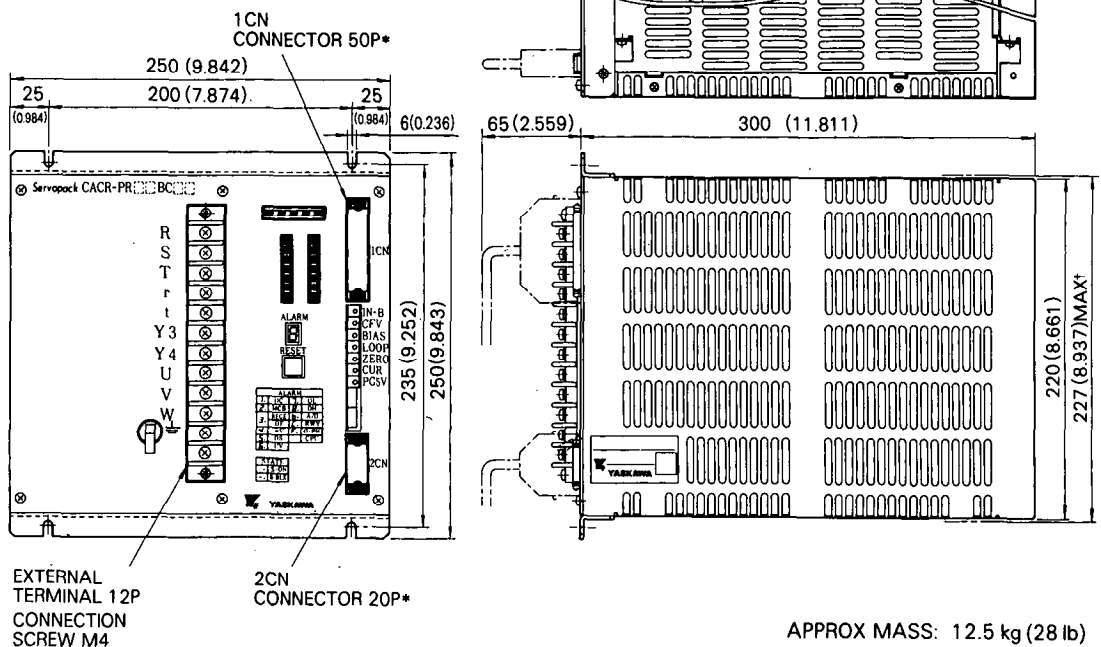

*Made by Honda Tsushin Co.

†Including mounting flange thickness.

8.5 PERIPHERAL EQUIPMENT

Power Supply for Brake

According to the motor, select either M/F series or S series.

(a) Power supply unit for M and F series

- Input 100 VAC, output 90 VDC (OPR109F)
- Input 200 VAC, output 90 VDC (OPR109A)

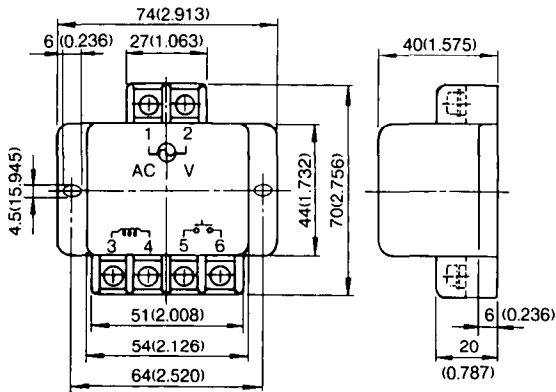

Circuit Diagram

- Type OPR109F

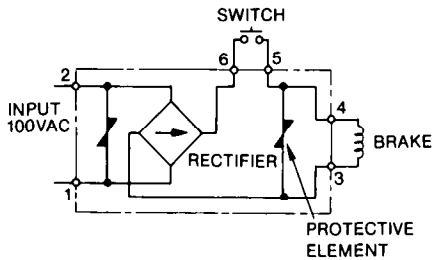

- Type OPR109A

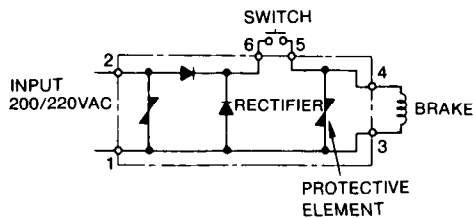

(b) Power supply unit for S series

- Input 100 VAC, 90 VDC (DP8401002-2)
- Input 200 VAC, 90 VDC (DP8401002-1)

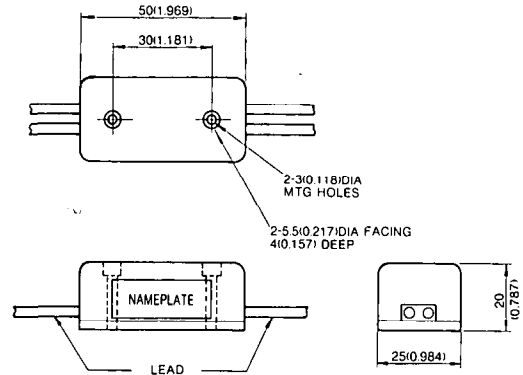

Note: Although opening and closing the brake power supply circuit is possible from either the AC side or DC side, it is usually safer to open and close from the AC side.

Since the brake coil may be damaged due to surge voltage when opened or closed from AC side, always insert a surge suppressor near the brake coil.

Circuit Diagram

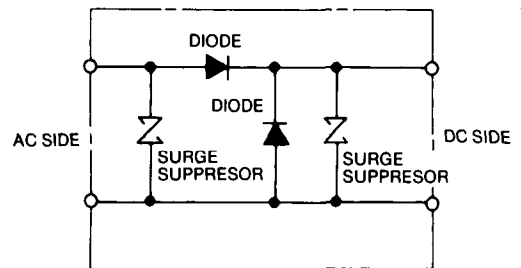

Notes:

1. Do not short between output terminals 3 and 4.
2. Switch (between terminals 5 and 6) conditions are as follows:
 - Contact capacity — five to ten times as large as rated current.
 - Contact for direct current.
3. Use the fuse on input or output side to protect the power unit.

9. TEST RUN

Before test run, check the following. Correct any deficiency.

9.1 CHECK ITEMS BEFORE TEST RUN

9.1.1 SERVOMOTOR

Before test run, check the following. If the test run is performed after long storage, see Par. 11, "INSPECTION AND MAINTENANCE".

- Connection to machines or devices, wiring, fuse connection, and grounding are correct.
- Bolts and nuts are tightened.
- For motors with shaft seals, the seals are not damaged and motor is properly lubricated.

9.1.2 SERVOPACK

- Setting switches are correctly set to satisfy the specifications for the applicable SERVOMOTOR and optical encoder.
- Connection and wiring leads are firmly connected to terminals or inserted into the connectors.
- The power supply is turned OFF if servo alarm outputs.
- Voltage supplied to SERVOPACK is 200 to $230V_{-15\%}^{+10\%}$. If a voltage line other than $200V$ is used, the voltage should be dropped to $200V$ through a power transformer.
- The speed reference should be $0V$ (speed reference circuit is short-circuited.)

9.2 TEST RUN PROCEDURES

9.2.1 Preparation for Operation

During test run, loads should not be applied to the SERVOMOTOR. If it is necessary to start with the driven machine connected to the motor, confirm that the driven system is ready for emergency stop at any time.

(1) Power ON

- After checking items in Par. 9.1, turn ON the power supply. When the power ON sequence is correct, according to Par. 6.1, the power is turned ON by depressing the POWER pushbutton for approximately 1 second.
- When the power is correctly supplied, the following green LED light: **P** and **MP**.

- When a Servo ON signal is input (contact is ON), the power circuit in the SERVOPACK operates and the motor is ready to run.

9.2.2 Operation

The operation is possible only while Servo ON signal is on.

- Increase the speed reference voltage gradually from $0V$, then the motor will rotate at a speed proportional to the reference voltage.
- When the reference voltage is positive, the motor rotates forward (counterclockwise viewed from drive end—output shaft) (Fig. 9.1).

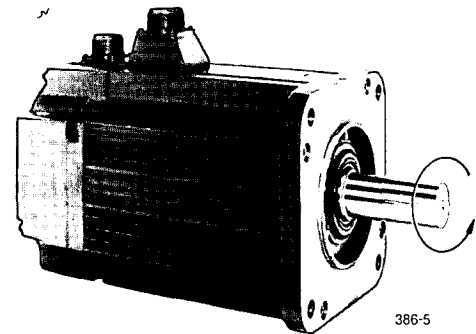

Fig. 9.1 Motor Forward Running

9.2.3 Inspection during Test Run

The following items should be checked for during the test run.

- Unusual vibration
- Abnormal noise
- Excessive temperature rise

If any abnormality is found, take corrective actions according to Par. 12. At a test operation, the load and machine may not fit well at first and result in overload.

10. ADJUSTMENT

10.1 SETTINGS AT THE TIME OF DELIVERY

Table 10.1 Standard Setting Specifications

Item		Standard Specifications	
Reference Pulse		Input Form	Sign + pulse train
		Voltage Level	+ 12V
Control Signal	\overline{CL}	Effective Logic	Active at L level
		Voltage Level	+ 12V
	\overline{INH}	Effective Logic	Active at L level
		Voltage Level	+ 12V
Frequency Dividing	Frequency Dividing (1)*		1/2 to 1/6
	Frequency Dividing (2)		1/1
	Multiplier Mode		×2
D/A Converter Bit Number*		11 and 12 bits	
Positioning Completion (COIN)		± 7 pulses	

*These data differs from motor series.

Note: Operating speed range is made frequency dividing setting for maximum speed. If the resolution for positioning encoder is required to heighten, change the setting of frequency dividing (1), (2) and multiplier mode.

Table 10.2 3P Switch Setting

Switch	Standard Setting						
SL 1	<table style="border-collapse: collapse; margin: auto;"> <tr> <td style="padding: 0 5px;">1</td> <td style="padding: 0 5px;">2</td> <td style="padding: 0 5px;">3</td> </tr> <tr> <td style="border: 1px solid black; text-align: center;">0</td> <td style="border: 1px solid black; text-align: center;">0</td> <td style="text-align: center;">○</td> </tr> </table>	1	2	3	0	0	○
1	2	3					
0	0	○					
SL 2*	<table style="border-collapse: collapse; margin: auto;"> <tr> <td style="padding: 0 5px;">1</td> <td style="padding: 0 5px;">2</td> <td style="padding: 0 5px;">3</td> </tr> <tr> <td style="text-align: center;">○</td> <td style="text-align: center;">○</td> <td style="text-align: center;">○</td> </tr> </table>	1	2	3	○	○	○
1	2	3					
○	○	○					
SL10	<table style="border-collapse: collapse; margin: auto;"> <tr> <td style="padding: 0 5px;">1</td> <td style="padding: 0 5px;">2</td> <td style="padding: 0 5px;">3</td> </tr> <tr> <td style="text-align: center;">○</td> <td style="border: 1px solid black; text-align: center;">0</td> <td style="border: 1px solid black; text-align: center;">0</td> </tr> </table>	1	2	3	○	0	0
1	2	3					
○	0	0					
SL20	<table style="border-collapse: collapse; margin: auto;"> <tr> <td style="padding: 0 5px;">1</td> <td style="padding: 0 5px;">2</td> <td style="padding: 0 5px;">3</td> </tr> <tr> <td style="text-align: center;">○</td> <td style="border: 1px solid black; text-align: center;">0</td> <td style="border: 1px solid black; text-align: center;">0</td> </tr> </table>	1	2	3	○	0	0
1	2	3					
○	0	0					
SL30	<table style="border-collapse: collapse; margin: auto;"> <tr> <td style="padding: 0 5px;">1</td> <td style="padding: 0 5px;">2</td> <td style="padding: 0 5px;">3</td> </tr> <tr> <td style="border: 1px solid black; text-align: center;">0</td> <td style="border: 1px solid black; text-align: center;">0</td> <td style="text-align: center;">○</td> </tr> </table>	1	2	3	0	0	○
1	2	3					
0	0	○					
SL40*	<table style="border-collapse: collapse; margin: auto;"> <tr> <td style="padding: 0 5px;">1</td> <td style="padding: 0 5px;">2</td> <td style="padding: 0 5px;">3</td> </tr> <tr> <td style="text-align: center;">○</td> <td style="text-align: center;">○</td> <td style="text-align: center;">○</td> </tr> </table>	1	2	3	○	○	○
1	2	3					
○	○	○					

*No setting pin

10.1.1 List of Switch Setting

The SERVOPACK has been factory-adjusted as follows:

(1) M Series

Table 10.3 Standard Adjustment and Setting Specifications

SERVOPACK Type CACR-	Applicable SERVOMOTOR			SERVOPACK Adjustment		
	Type USAMED-	Optical Encoder pulses/rev	Rated Current A	Max Output Current A	Speed Setting	Resolution for Positioning Encoder
PR03 PR07 PR10 PR15 BC3AM PR20 PR30 PR44	03MA1 06MA1 09MA2 12MA2 20MA2 30MA2 44MA2	6000	3.0 5.8 7.6 11.7 18.8 26.0 33.0	7.3 13.9 16.6 28.0 42.0 56.5 70.0	2000 r/min at 66.7 kpps reference pulses	2000 pulses/rev
PR03 PR07 PR10 PR15 BC3BM PR20 PR30 PR44	03MB1 06MB1 09MB2 12MB2 20MB2 30MB2 44MB2	5000	3.0 5.8 7.6 11.7 18.8 26.0 33.0	7.3 13.9 16.6 28.0 42.0 56.5 70.0		
PR03 PR07 PR10 PR15 BC3DM PR20 PR30 PR44	03MD2 06MD2 09MD2 12MD2 20MD2 30MD2 44MD2	4000	3.0 5.8 7.6 11.7 18.8 26.0 33.0	7.3 13.9 16.6 28.0 42.0 56.5 70.0		

Table 10.4 Standard Factory-adjusted Switch Positions

SERVOPACK Type CACR-	Optical Encoder(PG) pulses/rev	SW 1	SW 2	SW 3	SW 4
		Motor Type, Combined PG Setting	Frequency Dividing(I) Setting	Speed Loop Condition Setting	Motor Characteristics, Servopack Function Setting
PR03BC3AM to PR44BC3AM	6000		$\times \frac{1}{6}$		
PR03BC3BM to PR44BC3BM	5000		$\times \frac{1}{5}$		
PR03BC3DM to PR44BC3DM	4000		$\times \frac{1}{4}$		
SERVOPACK Type CACR-	Optical Encoder(PG) pulses/rev	SW10	SW20	SW30	SW40
		Number of D/A Bit, COIN Setting†	Reference Pulse Input From Setting	Multiplier Mode Setting†	Effective Logic Setting of Control Signal †
PR03BC3□M to PR44BC3□M	6000 5000 4000				

* Spare plug

† For other functions, see Table 6.19.

Notes: 1. SW100 is spare for setting pin storage.

2. □ is A, B or D.

10. 1. 1 List of Switch Setting (Cont'd)

(2) F series

Table 10.5 Standard Adjustment and Setting Specifications

SERVOPACK Type CACR-	Applicable SERVOMOTOR			SERVOPACK Adjustment		
	Type USAFED-	Optical Encoder pulses/rev	Rated Current A	Max Output Current A	Speed Setting	Resolution for Positioning Encoder
PR03 PR05 PR10 PR15 BC3AF PR20 PR30 PR44	02FA1, 03FA1 05FA1 09FA1 13FA1 20FA1 30FA2 44FA2	6000	3.0 3.8 6.2 9.7 15.0 20.0 30.0	8.5 11.0 17.0 27.6 42.0 56.5 77.0	2500 r/min at 83.3 kpps reference pulses	2000 pulses/rev
PR03 PR05 PR10 PR15 BC3BF PR20 PR30 PR44	02FB1, 03FB1 05FB1 09FB1 13FB2 20FB2 30FB2 44FB2	5000	3.0 3.8 6.2 9.7 15.0 20.0 30.0	8.5 11.0 17.0 27.6 42.0 56.5 77.0		
PR03 PR05 PR10 PR15 BC3DF PR20 PR30 PR44	02FD1, 03FD1 05FD1 09FD1 13FD2 20FD2 30FD2 44FD2	4000	3.0 3.8 6.2 9.7 15.0 20.0 30.0	8.5 11.0 17.0 27.6 42.0 56.5 77.0		

Table 10.6 Standard Factory-adjusted Switch Positions

SERVOPACK Type CACR-	Optical Encoder(PG) pulses/rev	SW 1	SW 2	SW 3	SW 4
		Motor Type, Combined PG Setting	Frequency Dividing(I) Setting	Speed Loop Condition Setting	Motor Characteristics, Servopack Function Setting
PR03BC3AF to PR44BC3AF	6000	1 2 3 4 5 6 7 8 ○○○○○○○○	1 2 3 4 5 6 7 8* × $\frac{1}{6}$ ○○○○○○○○	1 2 3 4 5 6 7 8 ○○○○○○○○	1 2 3 4 5 6 7 8* ○○○○○○○○
PR03BC3BF to PR44BC3BF	5000	1 2 3 4 5 6 7 8 ○○○○○○○○	1 2 3 4 5 6 7 8* × $\frac{1}{5}$ ○○○○○○○○	1 2 3 4 5 6 7 8 ○○○○○○○○	
PR03BC3DF to PR44BC3DF	4000	1 2 3 4 5 6 7 8 ○○○○○○○○	1 2 3 4 5 6 7 8* × $\frac{1}{4}$ ○○○○○○○○	1 2 3 4 5 6 7 8 ○○○○○○○○	
SERVOPACK Type CACR-	Optical Encoder(PG) pulses/rev	SW 10	SW 20	SW 30	SW 40
		Number of D/A Bit, COIN Setting†	Reference Pulse Input Form Setting†	Multiplier Mode Setting†	Effective Logic Setting of Control Signal†
PR03BC3□F to PR44BC3□F	6000 5000 4000	1 2 3 4 5 6 7 8 ○○○○○○○○	1 2 3 4 5 6 7 8 ○○○○○○○○	1 2 3 4 5 6 7 8 ○○○○○○○○	1 2 3 4 5 6 7 8 ○○○○○○○○

* Spare plug

† For other functions, see Table 6.19

Notes: 1. SW100 is spare for setting pin storage.

2. □ is A, B or D.

(3) S series

Table 10.7 Standard Adjustment and Setting Specifications

SERVOPACK Type CACR-	Applicable SERVOMOTOR			SERVOPACK Adjustment		
	Type USASEM-	Optical Encoder pulses/rev	Rated Current A	Max Output Current A	Speed Setting	Resolution for Positioning Encoder
PR03BC3CS-Y41 PR03 PR05 PR10 BC3CS PR15 PR30	02AC2 03AC2 05AC2 08AC1 15AC1 30AC1	2500	2.1 3.0 4.2 5.3 10.4 19.9	6.0 8.5 11.0 15.6 28.0 56.5	4000 r/min at 66.7 kpps reference pulses	1000 pulses/rev
PR03BC3ES-Y41 PR03 PR05 PR10 BC3ES PR15 PR30	02AE2 03AE2 05AE2 08AE1 15AE1 30AE1	1500	2.1 3.0 4.2 5.3 10.4 19.9	6.0 8.5 11.0 15.6 28.0 56.5		
PR03BC3FS-Y41 PR03 PR05 PR10 BC3FS PR15 PR30	02AF2 03AF2 05AF2 08AF1 15AF1 30AF1	1000	2.1 3.0 4.2 5.3 10.4 19.9	6.0 8.5 11.0 15.6 28.0 56.5		

Table 10.8 Standard Factory-adjusted Switch Positions

SERVOPACK Type CPCR-	Optical Encoder (PG) pulses/rev	SW 1	SW 2	SW 3	SW 4
		Motor Type, Combined PG Setting	Frequency Dividing(I) Setting	Speed Loop Condition Setting	Motor Characteristics, Servopack Function Setting
PR03BC3CS to PR30BC3CS	2500		$\times \frac{1}{5}$	PR03BC PR05BC PR10BC 	
PR03BC3ES to PR30BC3ES	1500		$\times \frac{1}{3}$		
PR03BC3FS to PR30BC3FS	1000		$\times \frac{1}{2}$		
SERVOPACK Type CPCR-	Optical Encoder (PG) pulses/rev	SW10	SW20	SW30	SW40
		Number of D/A Bit, COIN Setting†	Reference Pulse Input Form Setting	Multiplier Mode Setting†	Effective Logic Setting of Control Signal†
PR03BC3CS to PR30BC3CS	2500 1500 1000				

* Spare plug

† For other functions, see Table 6.19.

Notes : 1. SW100 is spare for setting pin storage.

2. is C, E or F.

10.1.2 Potentiometer Setting

The factory-adjusted potentiometer positions on the panel is shown in Table 10.9. For potentiometer adjustment method, see Table 10.23.

Table 10.9 Standard Factory-adjusted Potentiometer Positions

Series	SERVOPACK Type CACR-	Position Loop Gain Adjustment	Speed Amplifier Zero Adjustment	Starting Current Adjustment	Speed Loop Gain Adjustment	Speed Reference Bias Compensation	Speed Reference Feed Forward Compensation	Voltage Adjustment of PG + 5V Power
		IN-B VR1	ZERO VR3	CUR VR5	LOOP VR6	BIAS VR15	CFV VR16	PG5V VR21
M	PR03BC3 M to PR44BC3 F	0 to 5/10	5/10	10/10	2 to 5/10	0/10	0/10	+ 5.25V
F	PR05BC3 F to PR44BC3 F				0 to 5/10			
S	PR03BC3 S to PR30BC3 S				0 to 4/10			

Notes:

1. In the Table above, / shows approximate scale of potentiometer.

For example, / indicates 7/10 scale.

2. The potentiometers other than listed in the Table above are provided for the SERVOPACK. Do not tamper with these potentiometers except for a special case as they have been preset at the factory.

10.2 LIST OF CHECK TERMINALS AND POTENTIOMETER

Table 10.10 lists check terminals and functions. For check terminals on the SERVOPACK panel.

Table 10.11 lists potentiometer inside SERVOPACK. These potentiometers have been adjusted at the factory. (Potentiometers should not be tampered with.)

Table 10.10 List of Check Terminals

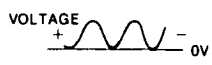
Equipment Symbol	Signal Name	Description																				
TM1	1 PA	PG input signals	Phase A pulse is input.																			
	2 *PA		Reverse pulse of phase A is input.																			
	3 PB		Phase B pulse is input.																			
	4 *PB		Reverse pulse of phase B is input.																			
	5 PC		Phase C pulse is input.																			
	6 *PC		Reverse pulse of phase C is input.																			
	7	—	Unused																			
8	PG5V	PG supply voltage +5V																				
TM2	1 PU	Waveform at motor forward rotation	Phase U pulse is input from pole sensor.																			
	2 *PU		Reverse pulse of phase U is input.																			
	3 PV		Phase V pulse is input from pole sensor.																			
	4 *PV		Reverse pulse of phase V is input.																			
	5 PW		Phase W pulse is input from pole sensor.																			
	6 *PW		Reverse pulse of phase W is input.																			
	7	DIR	Monitors the setting of direction of motor rotation.																			
8	PG0V	0V of the PG power supply (PG: common terminal to signals from the pole sensor)																				
TM3	1	OC	Overcurrent detection signal output																			
	2	—	Unused																			
	3	Vto	Monitors the motor speed ± 4.0 VDC/1000r/min. (M, F Series), ± 2.0 VDC/1000r/min (S Series).																			
	4	T-Mon	Monitors the reference torque ± 3.0 VDC/100%																			
	5	T-Ref	Torque reference ± 2.0 to ± 3.0 VDC/100%																			
	6	U-sin	Monitors phase U sin waveform.	 <ul style="list-style-type: none"> • Frequency varies depending on speed. • Amplitude varies depending on torque. 																		
	7	V-sin	Monitors phase V sin waveform.																			
	8	—	Unused																			
TM4	1	IU	Phase U current monitor.	<table border="1"> <thead> <tr> <th>Type CACR-SR</th> <th>03</th> <th>05</th> <th>07</th> <th>10</th> <th>15</th> <th>20</th> <th>30</th> <th>44</th> </tr> </thead> <tbody> <tr> <td>Monitor Voltage (V/A)</td> <td>0.4</td> <td>0.24</td> <td>0.20</td> <td>0.16</td> <td>0.08</td> <td></td> <td>0.04</td> <td></td> </tr> </tbody> </table>	Type CACR-SR	03	05	07	10	15	20	30	44	Monitor Voltage (V/A)	0.4	0.24	0.20	0.16	0.08		0.04	
	Type CACR-SR	03	05		07	10	15	20	30	44												
	Monitor Voltage (V/A)	0.4	0.24	0.20	0.16	0.08		0.04														
	2	IV	Phase V current monitor.																			
	3	ACON	Main power ON signal.																			
	4	AU	Phase U current amplification output monitor.																			
	5	AV	Phase V current amplification output monitor.																			
	6	AW	Phase W current amplification output monitor.																			
7	OSC2	Carrier frequency (triangle pulse)																				
8	SG	Signal 0V																				
TM10	1	D/A	Error counter D/A converter output																			
	2	BIAS	Speed reference bias compensation																			
	3	PH-A	Frequency dividing(1) output	PG-A phase pulse	Frequency dividing(2) output	PULSE signal																
	4	PH-B		PG-B phase pulse		SIGN signal																
	5	T4	Clock	LSI for error counter																		
	6	T24	Signal	LSI for frequency dividing(2)																		
	7	S-ON	Servo-ON signal (Servo ON at L)																			
	8	SG	Signal 0V																			
CH1	OV	Signal 0V (analog signal level 0V)																				

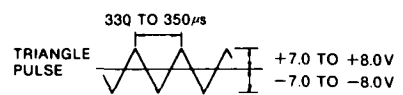
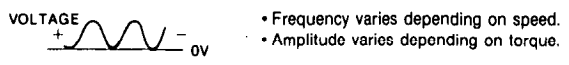
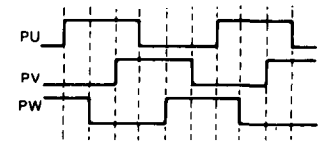
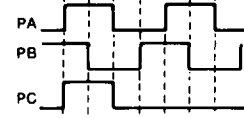

Notes:

1. For check terminals on SERVOPACK panel, see Table 6. 24.
2. The check terminals allow oscilloscope connection for measurement.

3. During measurement, do not short the adjacent two check terminals, as the connected elements may be destroyed by this.
4. [TM5] check terminal is for use only by the manufacturer. Do not make any measurement with it.

10.3 ADJUSTMENT PROCEDURES

Fig. 10.1 shows waveforms at the respective check terminals. Table 10.12 shows gain adjustment method of SERVOPACK.

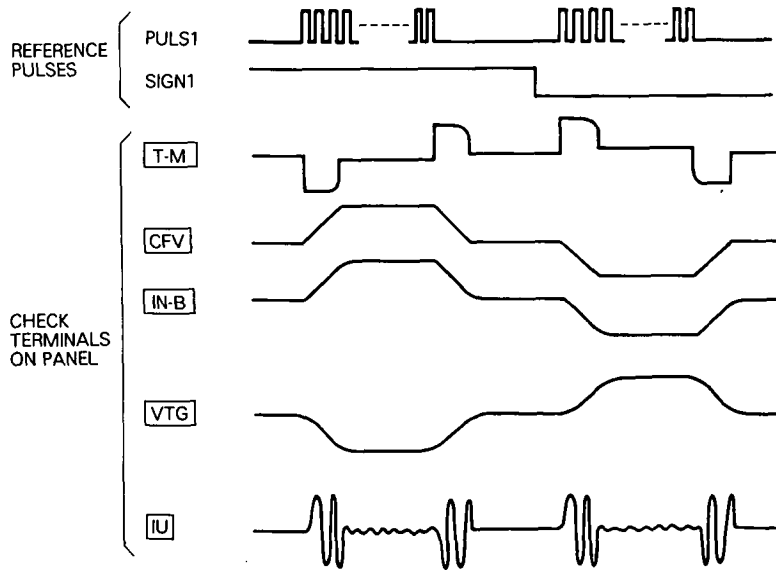

Fig. 10.1 Check Terminal Waveform at Normal

Table 10.12 Servo Gain Adjustment (at Potentiometer on the panel)

Item	How to Adjust	Remarks
<p>Overshoot occurs.</p>	<ul style="list-style-type: none"> Turn IN-B CCW to decrease the position loop gain. Turn LOOP CW to increase the gain. 	<ul style="list-style-type: none"> Adjust the gain gradually. If IN-B or LOOP gain is too high, motor vibrates.
<p>Follow-up response is bad.</p>	<ul style="list-style-type: none"> Turn IN-B CW to increase the position loop gain. 	<ul style="list-style-type: none"> If the variable range of IN-B is small, change the D/A converter bit. For example, where the D/A converter bit is changed from 10 bits to 9 bits, gain becomes two times.
<p>To short the positioning time further</p> <p>* Monitor by inverting the polarity.</p>	<ul style="list-style-type: none"> Apply the feedforward compensation using CFV. Note: If the follow-up time-lag of VTG is too large, feed forward compensation is ineffective. Apply the bias compensation using BIAS. 	<ul style="list-style-type: none"> If CFV and BIAS is not functioning effectively, perform as following: Set the setting pin of SW10-⑧ to ON. Turn IN-B CCW to decrease the gain, and set the setting pin of SW10-⑦ to OFF. Readjust the gain using IN-B.

11. INSPECTION AND MAINTENANCE

11.1 AC SERVOMOTOR

The AC SERVOMOTOR has no movable wearing parts (e.g. brushes), so simple daily inspection is sufficient. The inspection schedule for the motor is shown in Table 11.1.

Do not disassemble the motor. If disassembly should become necessary, contact your YASKAWA representative.

Table 11.1 Inspection Schedule for Motors

Inspection Item	Frequency	Inspection Operation
Vibration	Daily	Touch by hand.
Noise	Daily	Aurally
Exterior and Cleaning	As required	Clean with dry cloth or compressed air.
Insulation Resistance	Annually	Make sure that it is more than 10M Ω by measuring with a 500V megger after disconnecting the motor from the controller.
Shaft Seal	Every 5000 hours	If worn or damaged, replace after disconnecting the motor from the driven machine.
Total Inspection	Every 20,000 hours	Contact your YASKAWA representative.

11.2 SERVOPACK

The SERVOPACK is of contactless construction so that no special maintenance is required. Remove dust and tighten screws periodically.

12. TROUBLESHOOTING GUIDE

12.1 AC SERVOMOTOR

WARNING

Corrective actions in  should be performed after turning OFF the power.

Table 12.1 Troubleshooting Guide for AC SERVOMOTOR

Trouble	Cause	Corrective Actions
Motor does not start.	Voltage below rated	Measure voltage across motor terminals U, V, and W with a tester and correct to rated value.
	Loose connection	Tighten connection.
	Wrong wiring	Correct wiring.
	Overload	Reduce load or use a larger motor.
	Motor defective	Measure voltage across motor terminals U, V, and W with a tester. When correct, replace motor.
Unstable operation	Wrong wiring	Inspect and correct wiring across motor terminals U, V, and W, and PG.
Motor overheats.	Excessive ambient temperature.	Reduce below 40 °C.
	Motor dirty	Clean motor surface.
	Overload	Reduce load or use a larger motor.
Unusual noise	Motor loosely mounted	Tighten foundation bolts.
	Motor misaligned	Realign with driven machine.
	Coupling out of balance	Balance coupling.
	Noisy bearings.	Check alignment, loading of bearing, lubrication and contact your YASKAWA representative.
	Vibration of driven machine	Contact the machine manufacturer.

12.2 SERVOPACK

12.2.1 LED Indication (7-segment) for Troubleshooting

Table 12.2 LED Indication for Troubleshooting

LED	Detection	Lighting Condition	Probable Cause	Corrective Actions
1.	Over-current	Goes ON when power is supplied to the control circuit.	• Defective control circuit board (1 PWB).	• Replace the SERVOPACK.
		Goes ON when power is supplied to the main circuit and servo power is turned ON. • MCCB does not trip.	• Defective current feedback circuit. • Defective main circuit transistor module.	• Replace the SERVOPACK.
		Goes ON when power is supplied to the main circuit and servo power is turned ON. • MCCB trips.	• Defective motor grounding • Defective main circuit transistor module.	• Replace the motor. • Replace the SERVOPACK.
		Goes ON when power is supplied to the main circuit.	• Defective main circuit transistor module.	• Replace the SERVOPACK.
		Goes ON when the motor starts or slows down.	• Incomplete (1 PWB) VR8 adjustment.	—
2.	Circuit protector tripped	Goes ON when power is supplied to the control circuit.	• Defective control circuit board (1 PWB).	• Replace the SERVOPACK.
		Goes ON when power is supplied to the main circuit.	• Defective main circuit thyristor-diode module. • MCCB trips.	• Replace the SERVOPACK. • Check the wiring leads and joints in the SERVOPACK.
3.	Regenerative trouble, Overflow	Goes ON when power is supplied to the control circuit.	• Defective control circuit board. (1 PWB).	• Replace the SERVOPACK.
		• Goes ON approximate 0.5 to 1 second after power is supplied to the main circuit. • Goes ON when reference pulse is input.	• Defective regenerative transistor. • Regenerative resistor disconnection. • Motor vibrates at lock status. • Overload • Servo gain is too low.	• Replace the SERVOPACK. • Check and replace the regenerative resistor. (Replace the SERVOPACK) • Adjust the Servo gain. • Check the wiring. • Slowing up or down.
4.	Over-voltage	Goes ON when the motor starts or slows down.	• Load inertia $J_L(GD^2)$ too large. • Defective regenerative circuit.	• Check the inertia of the machine with the value converted to the motor shaft. • Replace the SERVOPACK.
5.	Over-speed	When the reference is input, the motor runs fast and 5. goes ON.	• Motor connection error. • Optical encoder connection error. • The reference input voltage too large.	• Correct the motor connection. • Check and correct pulses in phases A, B, C, U, V and W with 2CN. • Decrease the reference input frequency. • Correct the setting of PG frequency dividing.
6.	Voltage drop	Goes ON when power is supplied to the main circuit.	• Defective main circuit thyristor-diode module.	• Replace the SERVOPACK.
7.	Overload	Goes ON when power is supplied to the control circuit.	• Defective control circuit board (1 PWB).	• Replace the SERVOPACK.
		Goes ON during operation. • When power to the control circuit is turned OFF and then turned ON again, the operation starts.	• Operation with 105% to 130% or more of the rated load.	• Check and correct the load (may be overload).
R.	Heat sink overheat	Goes ON during operation. • When power to the control circuit is turned OFF and then turned ON again, 7. or R. goes ON again. When reset later, the operation starts.	• Fan has stopped. • Temperature around the Servopack exceeds 55°C.	• Check the fan. (SR20, 30, 44, 60) • Decrease the temperature below 55°C (The heat sink may be overheated.)
		The motor rotates, but the torque is unavailable. When power to the control circuit is turned OFF and then turned ON again, the operation starts, but the torque is still unavailable.	• Motor circuit error connection, such as U→V, V→W, W→U or single-phase connection.	• Correct the connection.

12.2.1 LED Indication (7-segment) for Troubleshooting (Cont'd)

Table 12.2 LED Indication for Troubleshooting (Cont'd)

LED	Detection	Lighting Condition	Probable Cause	Corrective Actions
<input checked="" type="checkbox"/>	A/D error	Goes ON when power is supplied to the control circuit.	• Defective control circuit board (1PWB).	• Replace the SERVOPACK.
<input type="checkbox"/>	CPU error	Goes ON during operation.	• Faulty internal elements.	• Resume after reset operation.
			• Defective internal elements.	• Replace the SERVOPACK.
<input checked="" type="checkbox"/>	Open phase	Goes ON when power is supplied to the control circuit.	• Defective control circuit board (1 PWB).	• Replace the SERVOPACK.
		Goes ON when power is supplied to the main circuit.	• Poor connection to 3-phase power supply.	• Check and correct the connection.
<input checked="" type="checkbox"/>	Overrun prevention	Goes ON when power is supplied to the control circuit.	• Defective control circuit board (1 PWB).	• Replace the SERVOPACK.
		The motor starts momentarily, then <input checked="" type="checkbox"/> goes ON.	• Motor connection error. • Optical encoder connection error.	• Correct the motor connection. • Check and correct pulses in phases A, B, C, U, V and W with 2CN.

12.2.2 Examples of Troubleshooting for Defective Wiring or Parts

Table 12.3 Example of Troubleshooting for Defective Wiring or Parts

Trouble	Check Items	Corrective Actions
MCCB trips immediately after Power On and Servo On.	• Main circuit wiring (such as motor grounding)	• Correct the wiring.
The reference is input, but the motor does not run.	• Voltage across Ⓑ, Ⓔ, and Ⓙ.	• Check the AC power supply circuit.
	• LED <input checked="" type="checkbox"/> and <input checked="" type="checkbox"/> ON	• If LEDs are on, check the cause.
	• Trouble LED OFF	• Check the wiring of reference input.
	• Reference pulse • Clear signal, alarm release signal input.	

12.2.3 Examples of Troubleshooting for Incomplete Adjustment

Table 12.4 Examples of Troubleshooting for Incomplete Adjustment

Trouble	Cause	Corrective Actions
• Motor vibrates when the power supply is turned on or when the motor is running.	• Speed loop gain or position loop gain is too high.	• Turn <input checked="" type="checkbox"/> or <input checked="" type="checkbox"/> CCW to decrease the gain.
• Overshoot is too large at motor starting and stopping.	• Starting or stopping current is saturating. • Position loop gain is too high.	• Turn <input checked="" type="checkbox"/> CCW. • Apply the reference pulse slowed up or down.
• Alarm by overflow occurs.	• Position loop gain is too low. • Load is large.	• Turn <input checked="" type="checkbox"/> CW. • Apply the reference pulse slowed up or down.

NOTES

AC SERVO DRIVES

M, F, S SERIES FOR POSITIONING CONTROL.

SERVOMOTOR TYPES : USAMED, USAFED, USASEM

(With Incremental Encoder)

SERVOPACK TYPE : CACR-PR□BC (Rack-mounted Type)

TOKYO OFFICE Ohtemachi Bldg, 1-6-1 Ohtemachi, Chiyoda-ku, Tokyo, 100 Japan

Phone (03) 3284-9111 Telex YASKAWA J33530 Fax (03) 3284-9034

SEOUL OFFICE Seoul Center Bldg, 91-1, So Kong-Dong, Chung-ku, Seoul, Korea

Phone (02) 776-7844 Fax (02) 753-2639

TAIPEI OFFICE Shen Hsiang Tang Sung Chiang Building 10F 146 Sung Chiang Road, Taipei, Taiwan

Phone (02) 563-0010, -7732 Fax (02) 567-4677

YASKAWA ELECTRIC AMERICA, INC. : SUBSIDIARY

Chicago-Corporate Headquarters 2942 MacArthur Blvd. Northbrook, Illinois 60062-2028, U.S.A.

Phone (708) 291-2340 Fax (708) 498-2430

Chicago-Technical Center 3160 MacArthur Blvd. Northbrook, Illinois 60062-1917, U.S.A.

Phone (708) 291-0411 Fax (708) 291-1028

Los Angeles Office 5626 Corporate Avenue Cypress, CA 90630 U.S.A.

Phone (714) 828-9692 Telex (230) 678396 YASKAWAUS TSTN Fax (714) 828-1165

New Jersey Office Riverdale One, 44 Route 23 North, Suite 5 Riverdale, NJ 07457-1619

Phone (201) 835-9512 Fax (201) 835-9511

YASKAWA ELECTRIC EUROPE GmbH : SUBSIDIARY

Niederhöchstädter Straße 73, 61476 Kronberg-Oberhöchstädt, Germany

Phone (06173) 938-0 Telex 415660 YASE D Fax (06173) 68421

YASKAWA ELÉTRICO DO BRASIL COMÉRCIO LTDA. : SUBSIDIARY

Rua Conde Do Pinhal 8-5, Andar Sala 51 CEP 01501-São Paulo-SP, Brasil

Phone (011) 35-1911 Fax (011) 37-7375

YASKAWA ELECTRIC (SINGAPORE) PTE. LTD.

CPF Bldg, 79 Robinson Road No. 13-05, Singapore 0106

Phone 2217530 Telex (87) 24890 YASKAWA RS Fax (65) 224-5854



YASKAWA

YASKAWA ELECTRIC CORPORATION